



Alumil
Building excellence every day

Alumil  **SMARTIA**
S350



CONTENTS

SMARTIA S350

DESIGN PHILOSOPHY & CHARACTERISTICS	4
SENSE OF FREEDOM	8
ATTENTION TO DETAIL	12
EXPLOITING EVERY CONTEMPORARY NEED	14
SECTIONS	16
INSTALLATION	28
APPLICATIONS	32
PERFORMANCE	33
REFERENCE PROJECTS	34

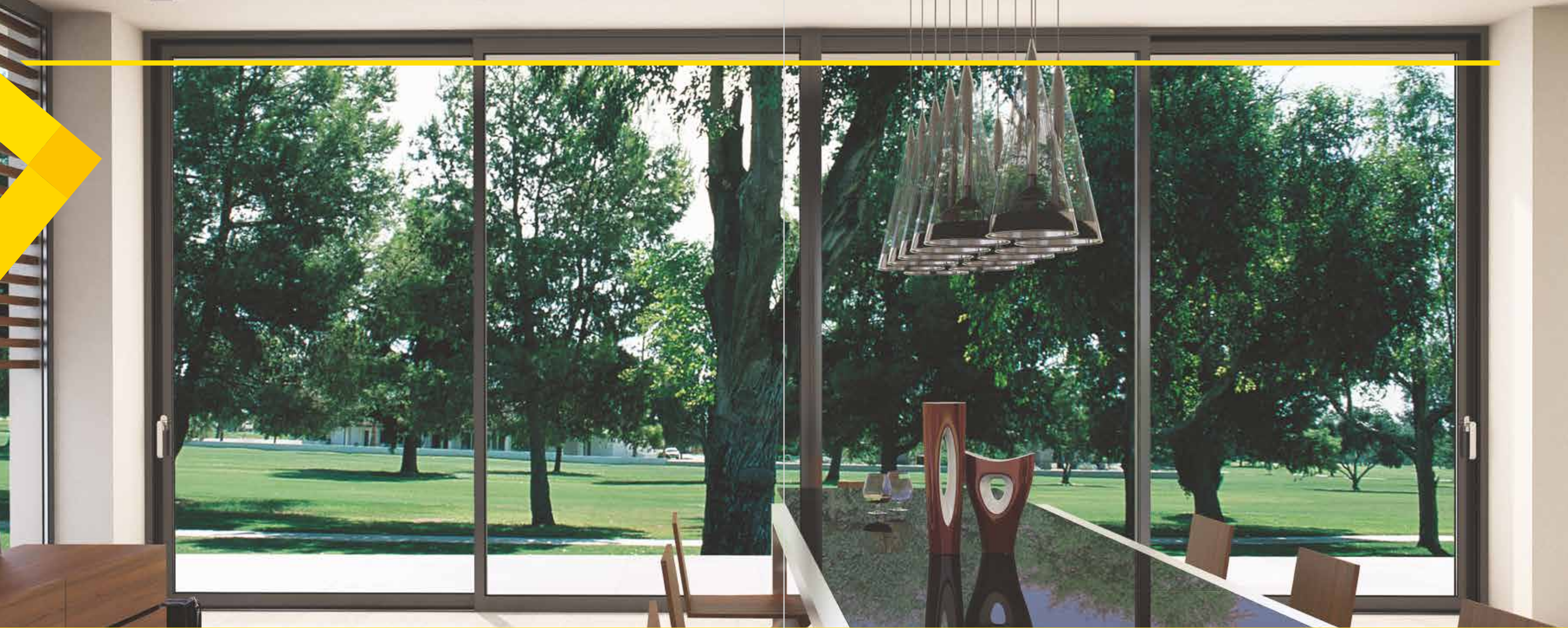

SMARTIA S350

is distinguished by the slim design and light profiles combined with substantial thermal insulation and high certified performances.

**Slim lines,
effortless operation**

SMARTIA S350
is a flexible insulated
sliding system ...

with a **modern flat design**. It is ideal
for refurbishments or renovations
thanks to its **construction easiness**.



- Basic system depth 35 mm.
- Maximum visibility and natural light with only 25 mm width at the interlocking profile.
- Easy access with low threshold ideal for renovations (version SMARTIA S350 LT).
- High thermal insulation with special sash available using anti-distortion polyamides, ideal for dark frames.
- Smooth and easy gliding, thanks to inox rails.
- Wide variety of typologies, compatible with various mechanisms.

Alumil SMARTIA
S350



TECHNICAL

CHARACTERISTICS



VISIBLE ALUMINIUM FACE WIDTH	101 / 116 mm
FRAME HEIGHT	32 / 38 mm
FRAME WIDTH	92 mm
SASH HEIGHT	76 / 85 mm
SASH WIDTH	35 mm
INTERLOCKING PROFILE WIDTH	25 / 50,5 / 88,5 mm
SASH WEIGHT	UP TO 180 KG
GLAZING	18 UP TO 28 mm
THERMAL INSULATION	POLYAMIDES 24 mm, PVC

SENSE

OF FREEDOM

The ideal combination of **elegant appearance**, seamless functionality and ease of construction.

ALTERNATIVE VERSION WITH LOW THRESHOLD:
for safe and easy access perfect for renovations.

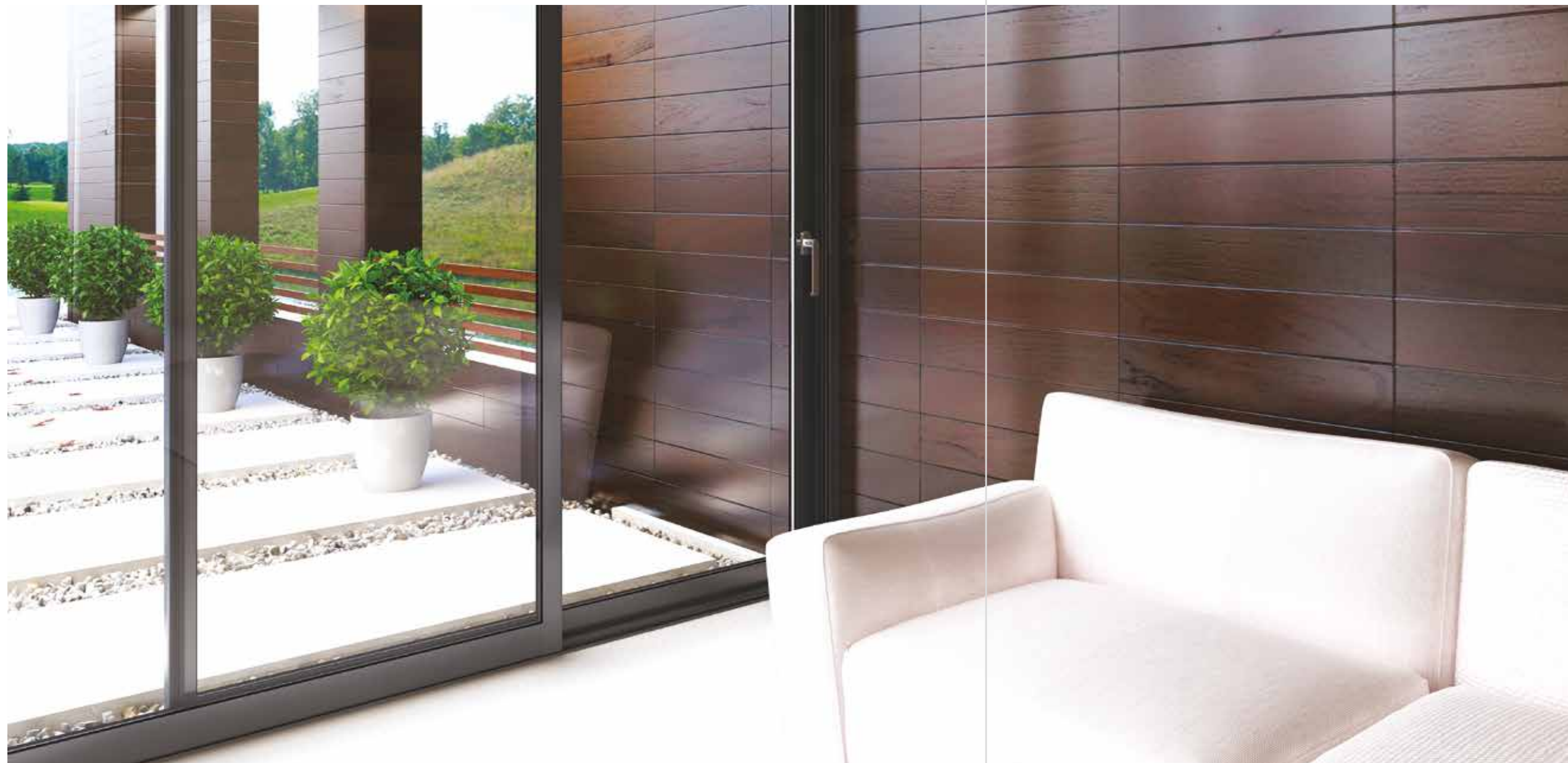

LOW THRESHOLD SMARTIA S350 LT



STANDARD THRESHOLD SMARTIA S350

Minimal design that enhances visibility...

and natural light with only **25 mm** width at the interlocking profile.



Available interlocking profile with **integrated reinforcement** empowers the construction against high wind pressures.

Alumil SMARTIA
S350

ATTENTION

TO DETAIL

High thermal insulation is achieved with **fiberglass reinforced polyamides**.

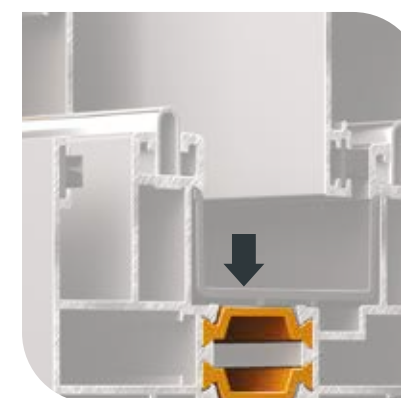

Available sash with special **anti-distortion polyamides** minimizes potential malfunctions caused by high-temperature fluctuations.



High quality brushes with **triple membrane** perimetrically of the sash, enhance the air permeability and watertightness.

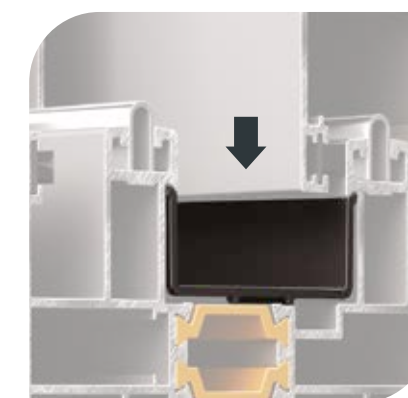
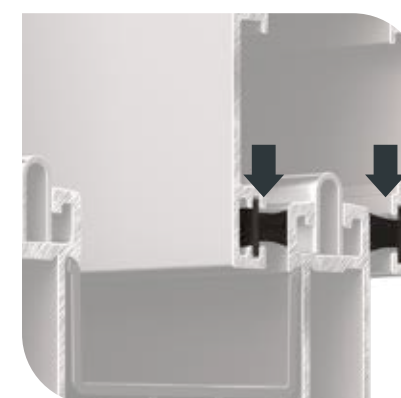

The **UV protected PVC profiles** for the track reduce the visible depth/complexity and contributes to the thermal insulation.

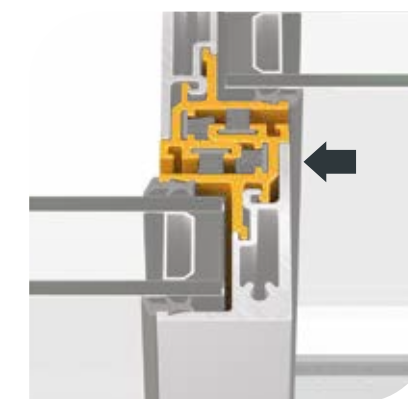

The specially designed **PVC profiles for the narrow interlocking profile** optimize air permeability and thermal insulation, enhancing energy saving.

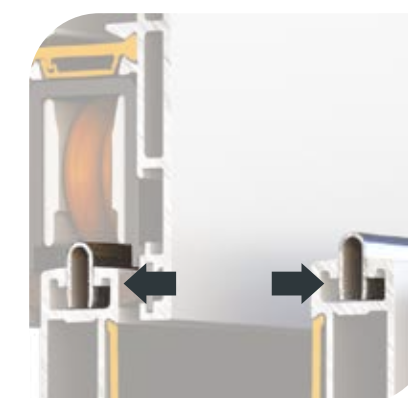

The sash glides **easily and quietly** on the rails made of stainless steel AISI 316L.

SASH PROFILES				
	S384	S390	S35011	S35013
TRACK PROFILE				
STANDARD THRESHOLD	•	•	•	•
LOW THRESHOLD	•	•	•	•
INTERLOCKING PROFILE				
NARROW 25 mm			•	
NARROW 50,5 mm	•	•		
STANDARD	•	•	•	•
ADJOINING PROFILE				
NARROW	•	•		
STANDARD	•	•	•	•
GLAZING WIDTH				
18 - 26 mm	•	•	•	•
28 mm			•	

EXPLOITING

EVERY CONTEMPORARY NEED

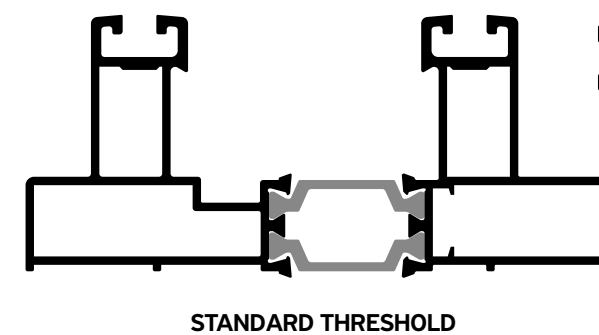
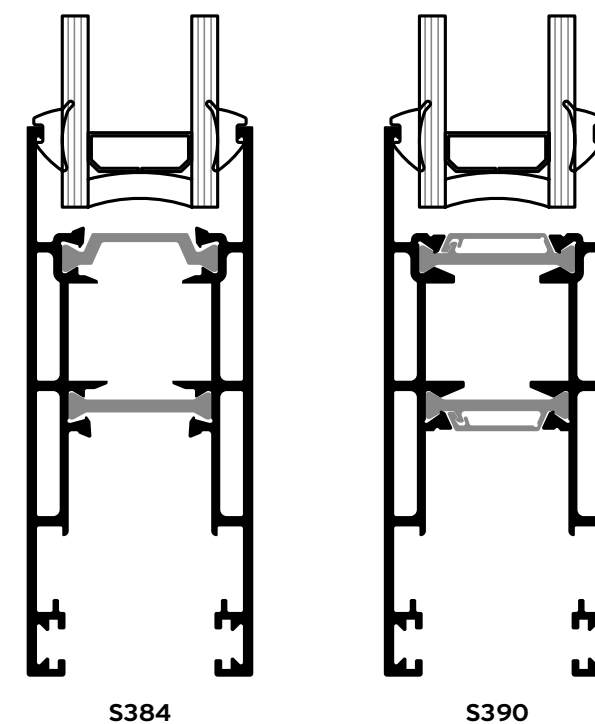
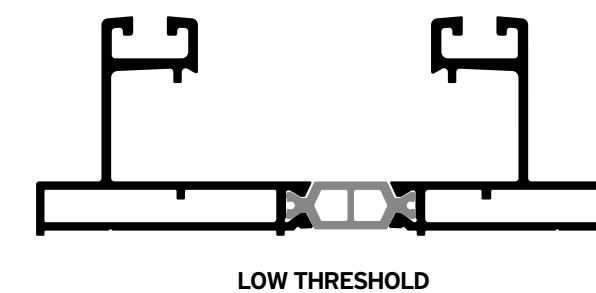
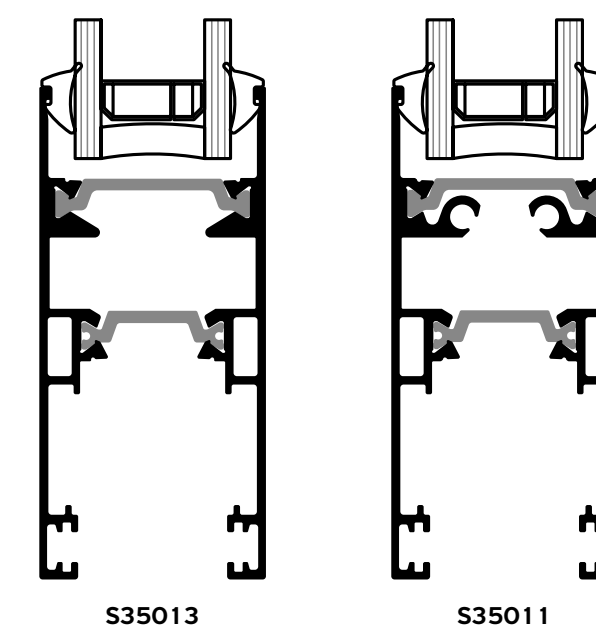
 ▶ SMARTIA
S350

 ▶ SMARTIA
S350 LT

Alumil SMARTIA
S350

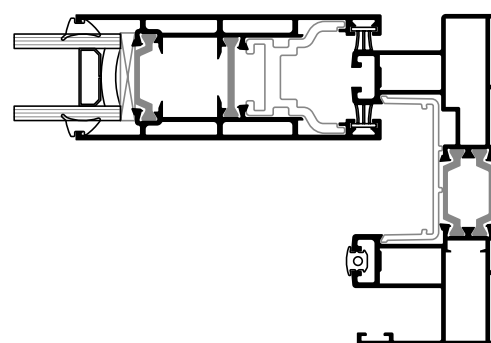
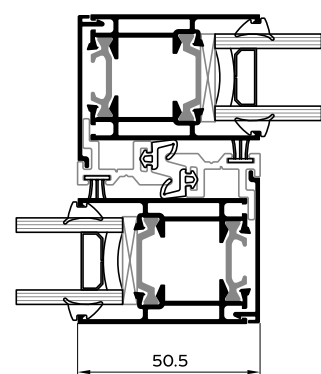
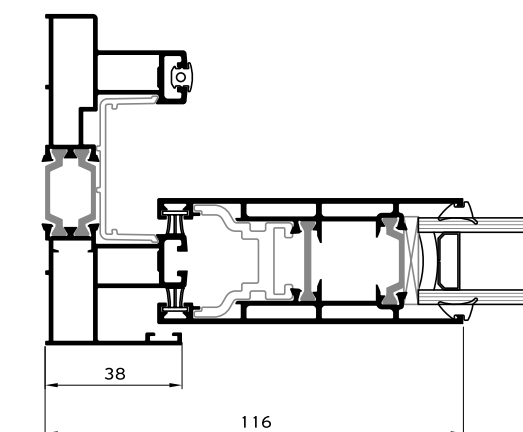
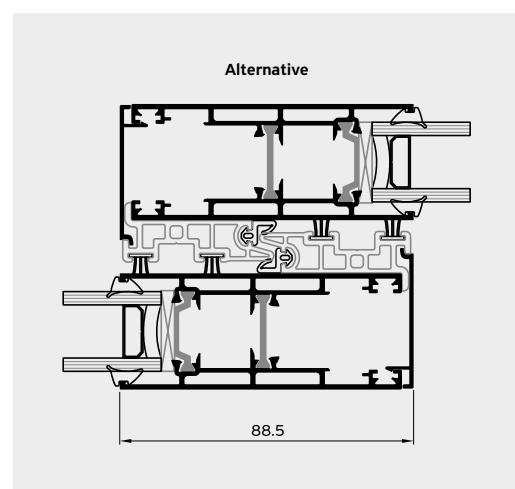
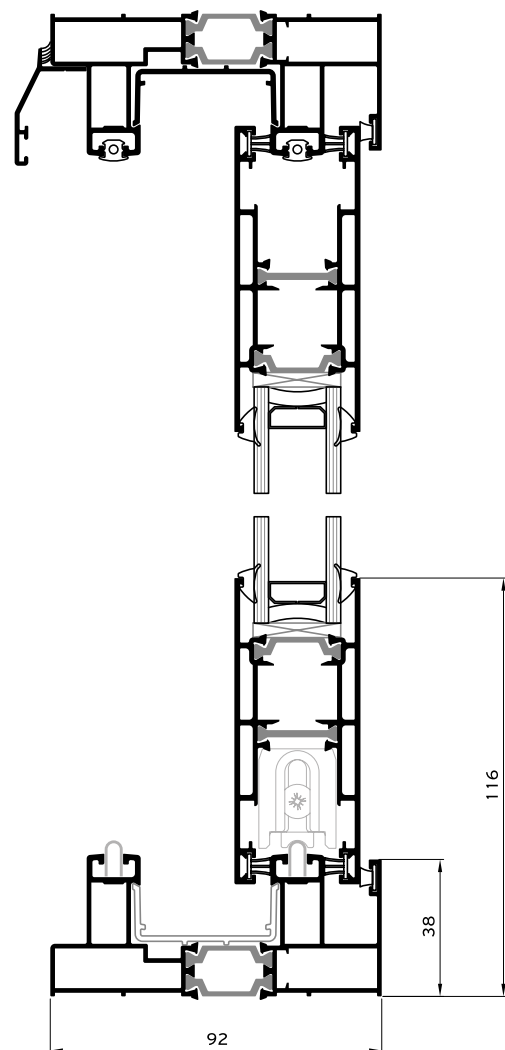
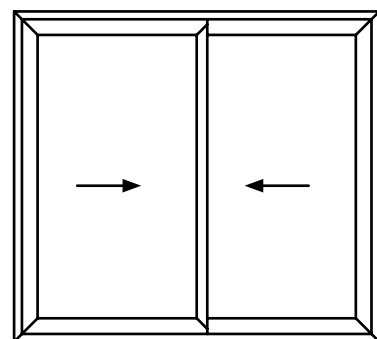
2 Sashes / 2 Track



Alumil SMARTIA
S350 LT

2 Sashes / 2 Track
Low Threshold

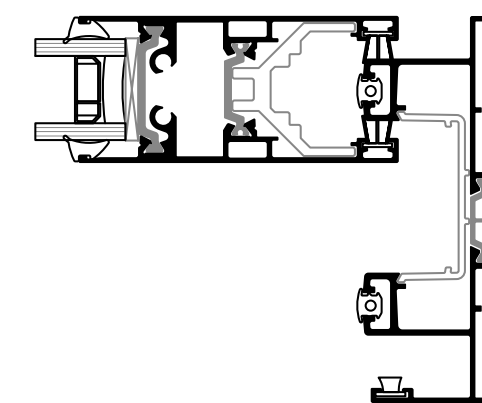
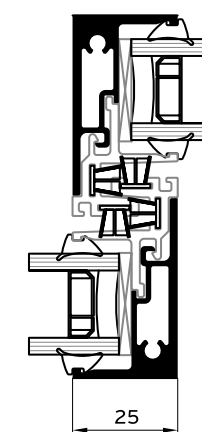
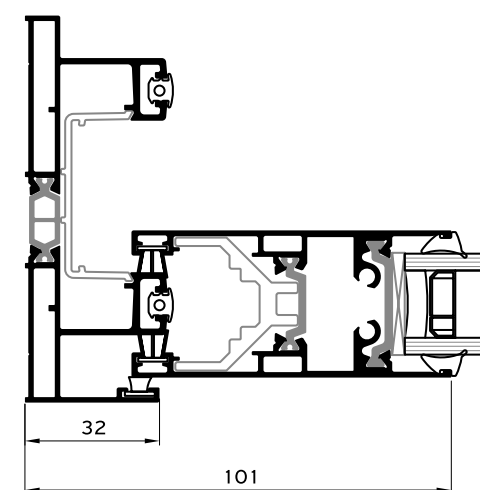
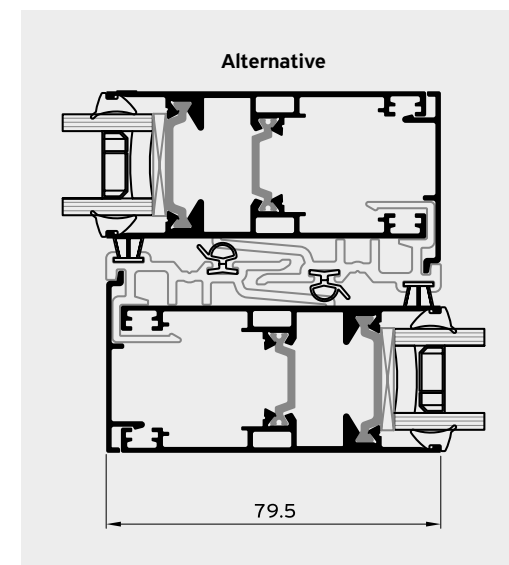
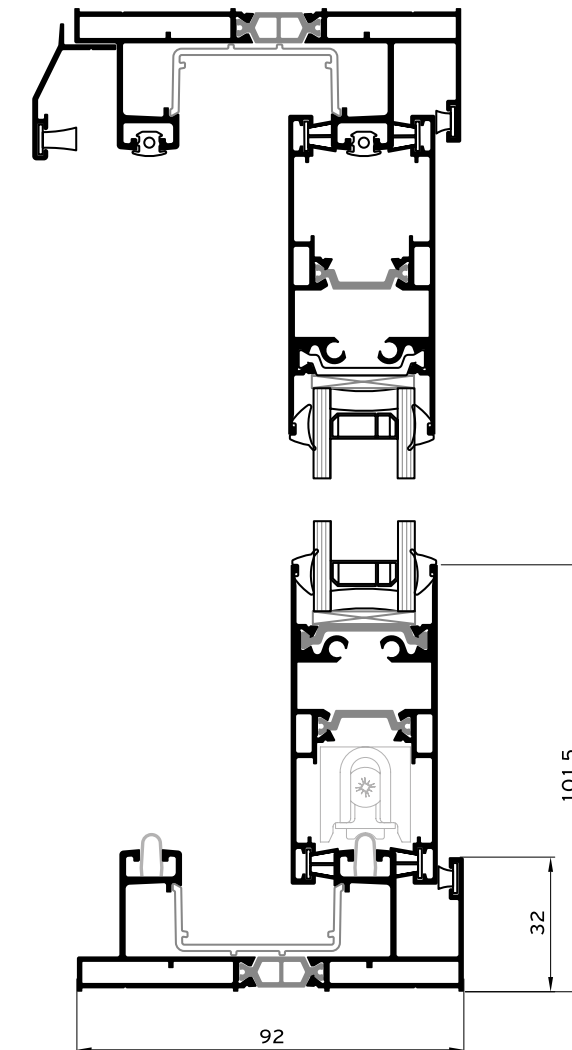
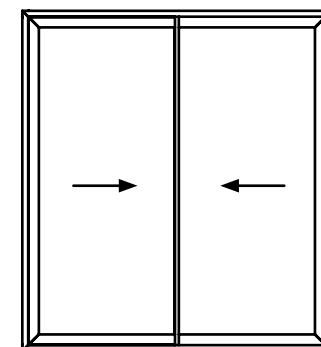

Alumil SMARTIA S350 **2 Sashes / 2 Track / Flyscreen**

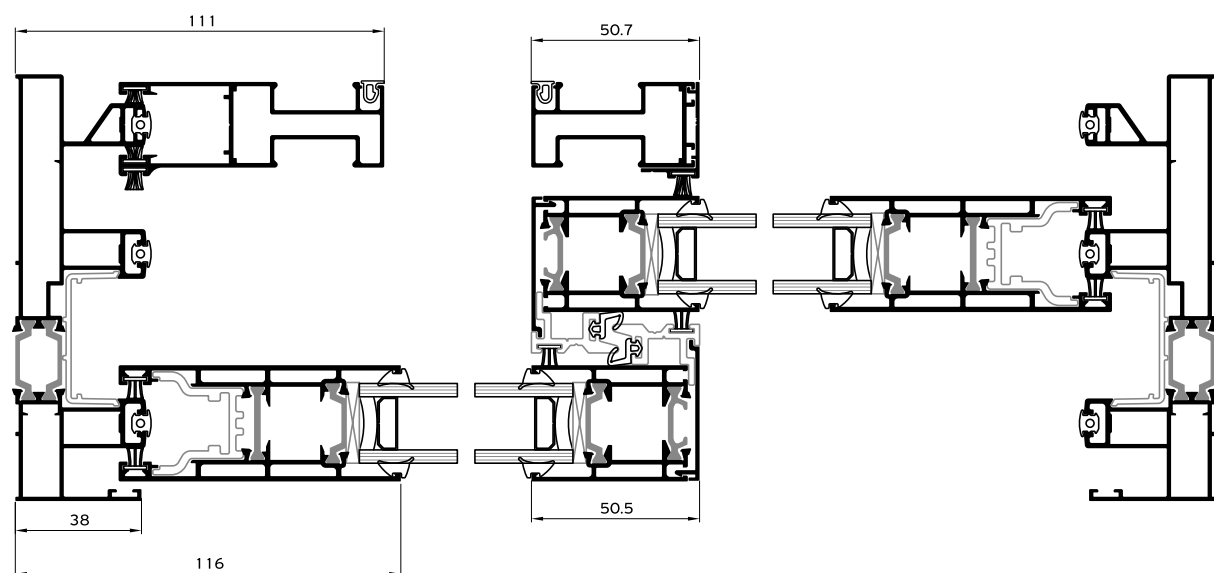
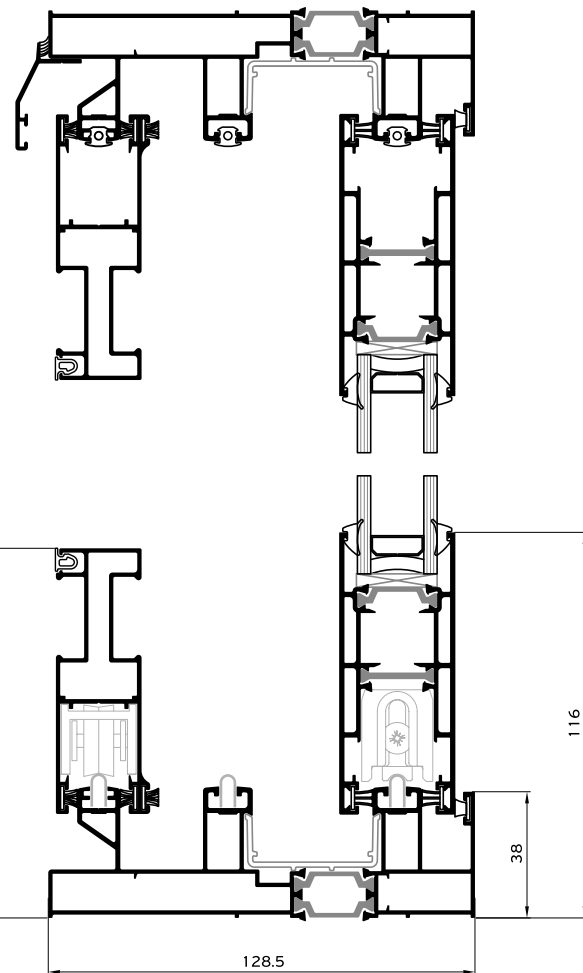
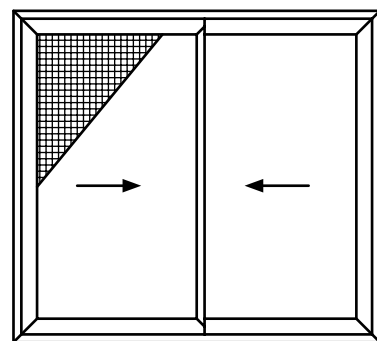

Alumil SMARTIA S350 LT **2 Sashes / 2 Track / Flyscreen**
Low Threshold

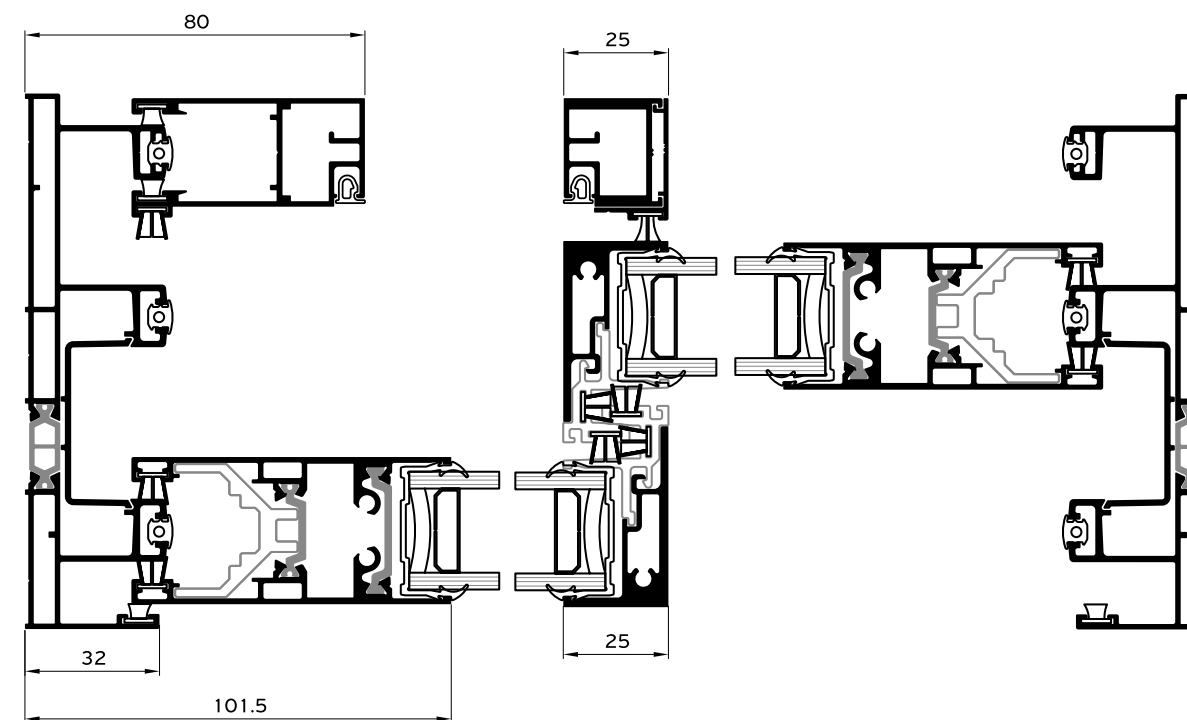
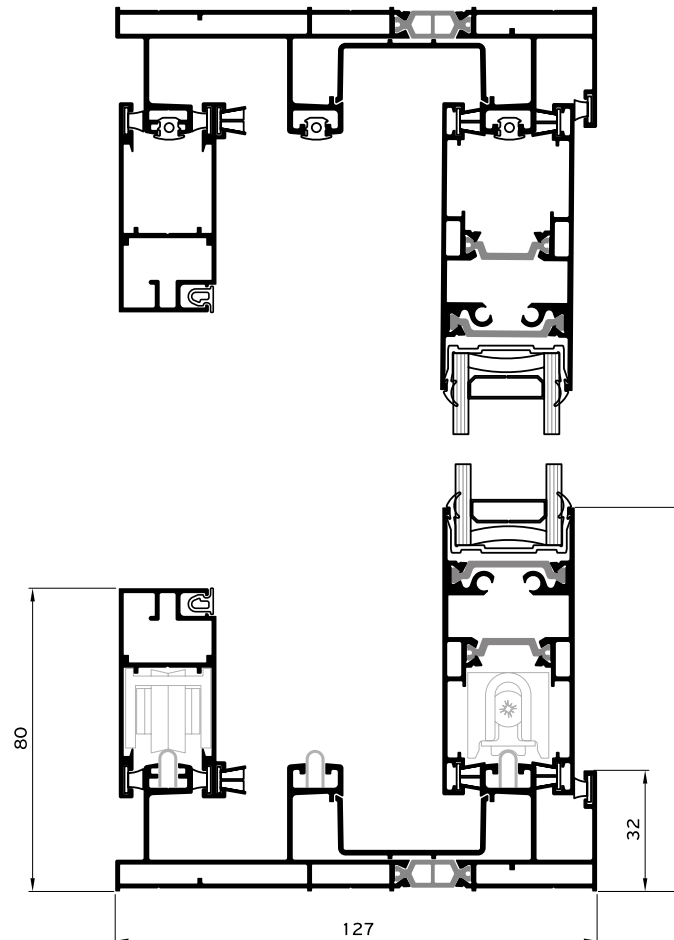
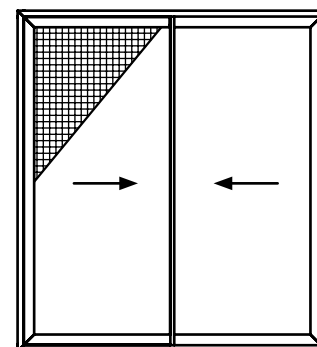

Alumil SMARTIA
S350

3 Sashes / 3 Track

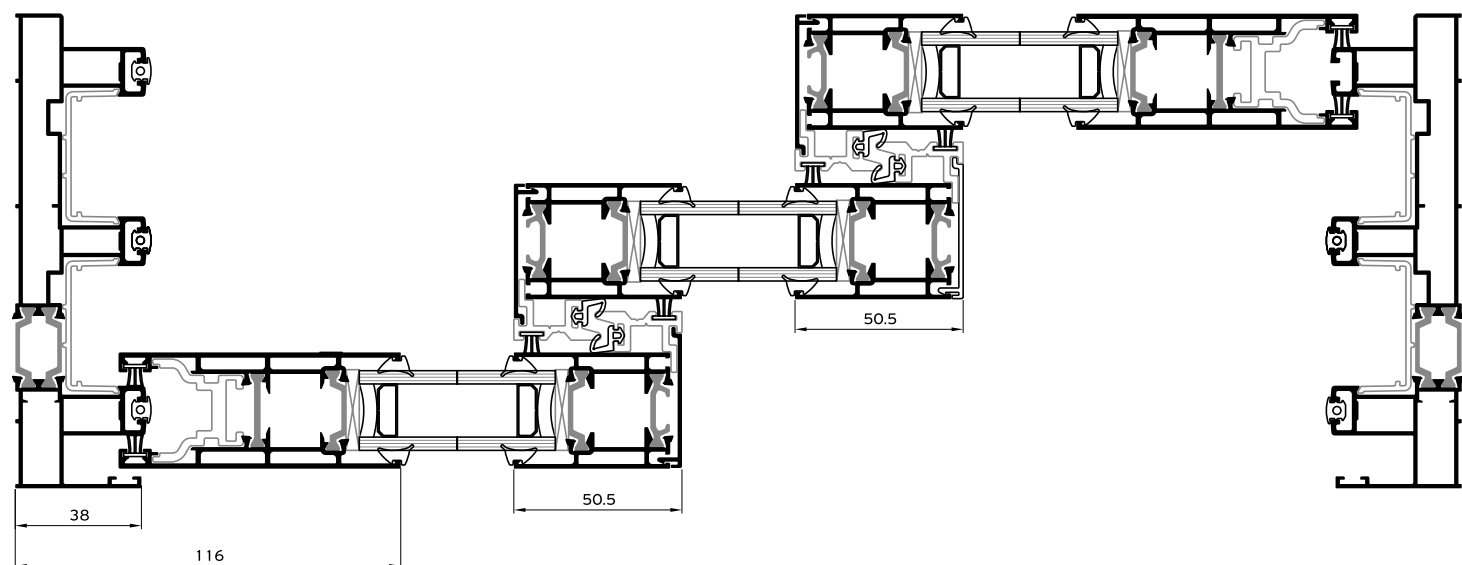
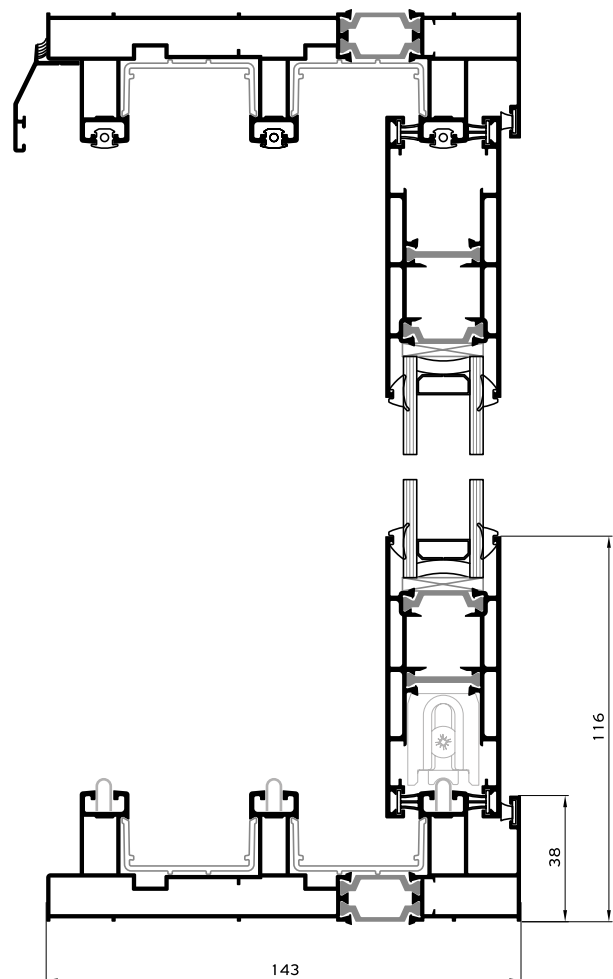
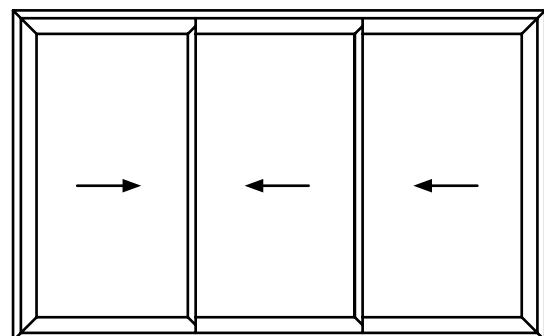

Alumil SMARTIA
S350 LT

3 Sashes / 3 Track
Low Threshold

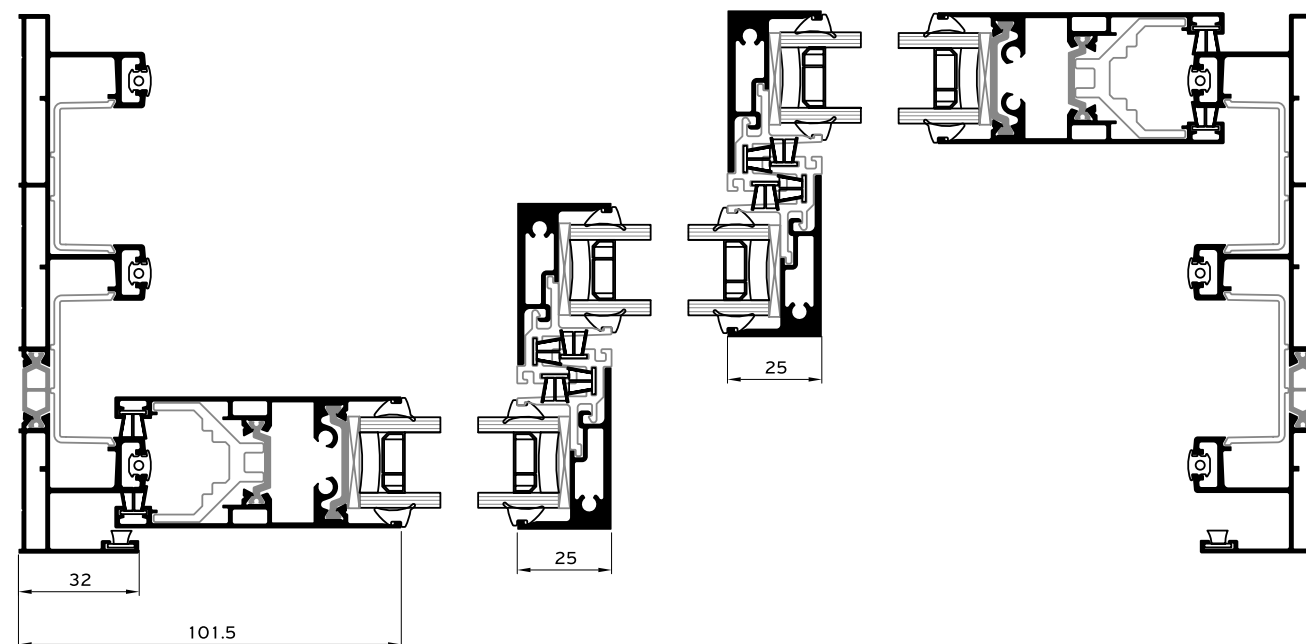
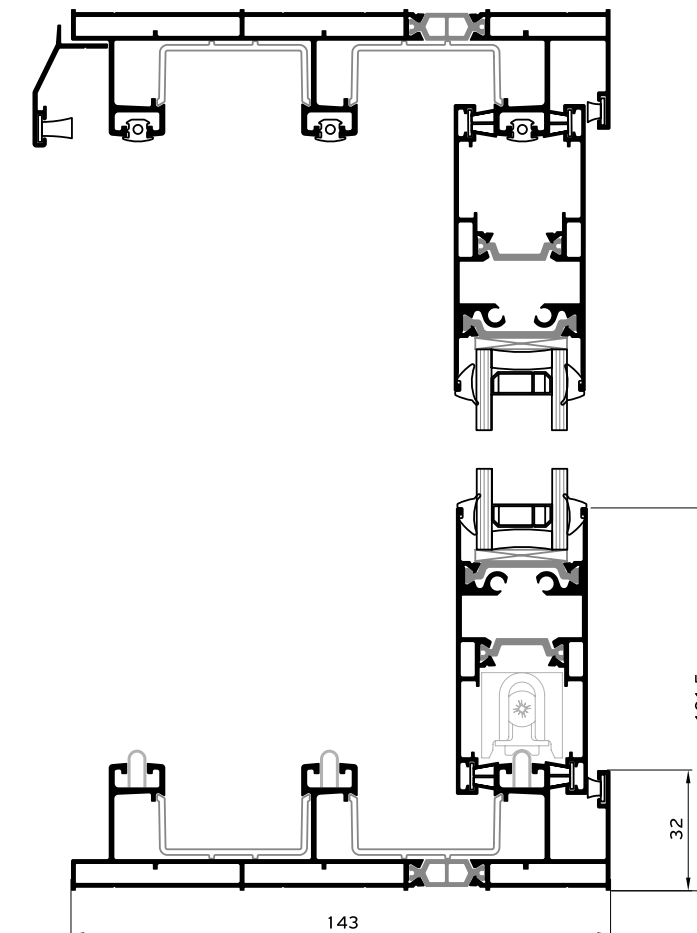
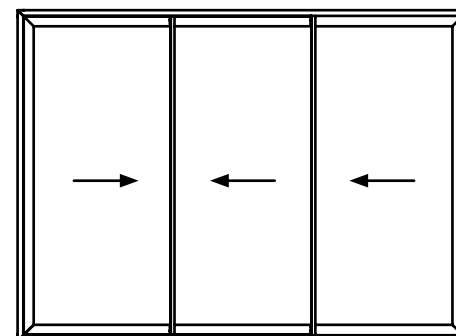

Alumil SMARTIA
S350

4 Sashes / 2 Track

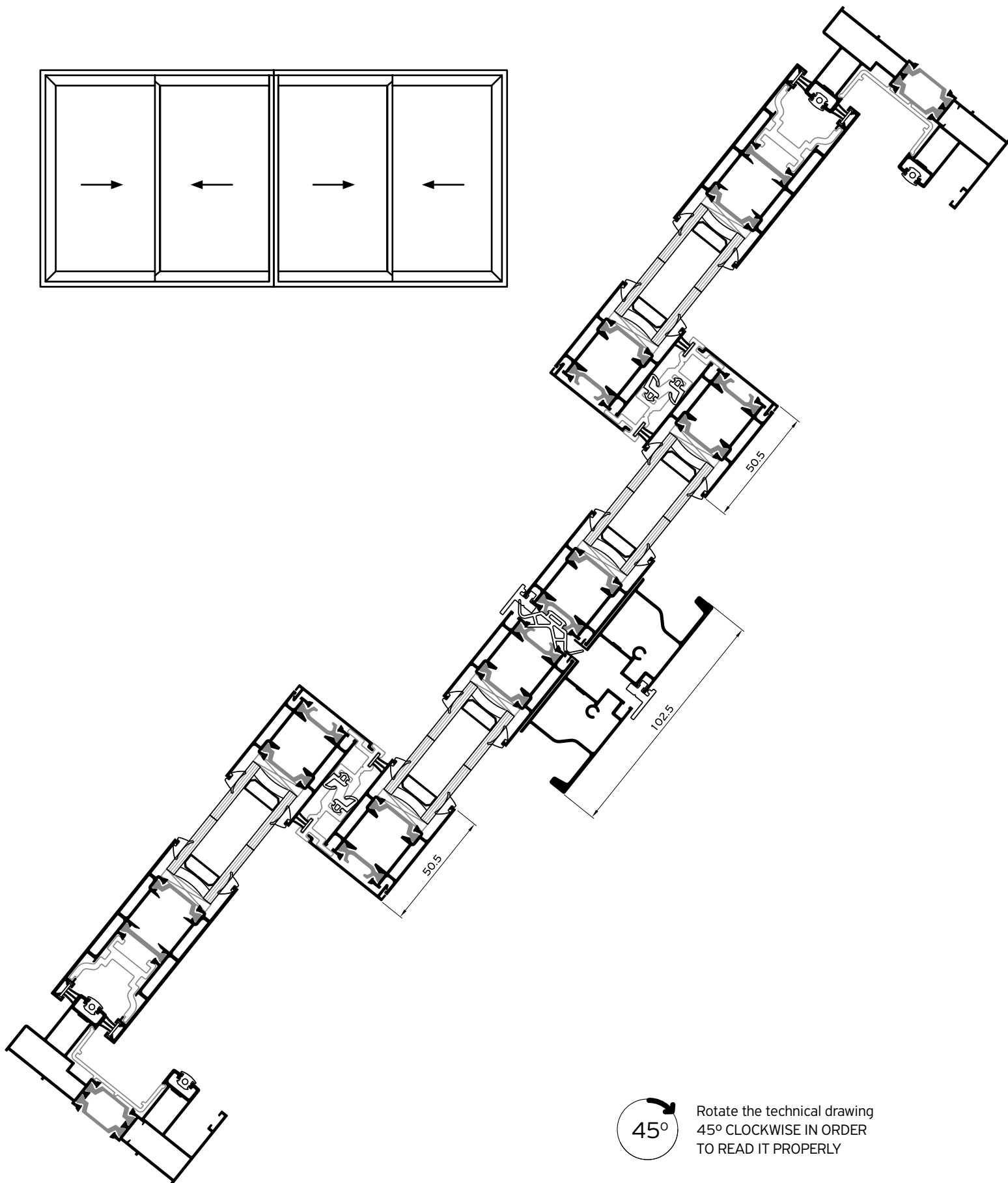
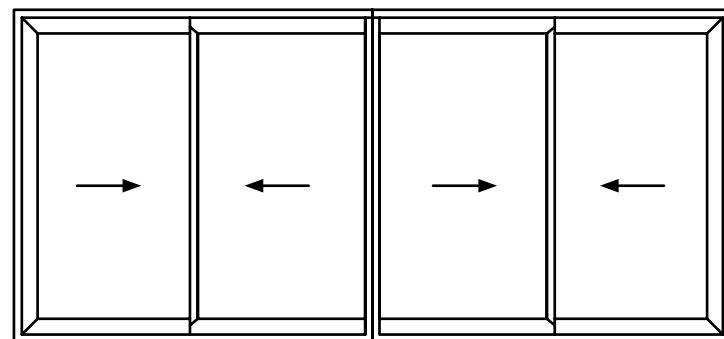

45° Rotate the technical drawing
45° CLOCKWISE IN ORDER
TO READ IT PROPERLY

Alumil SMARTIA
S350 LT

4 Sashes / 2 Track
Low Threshold

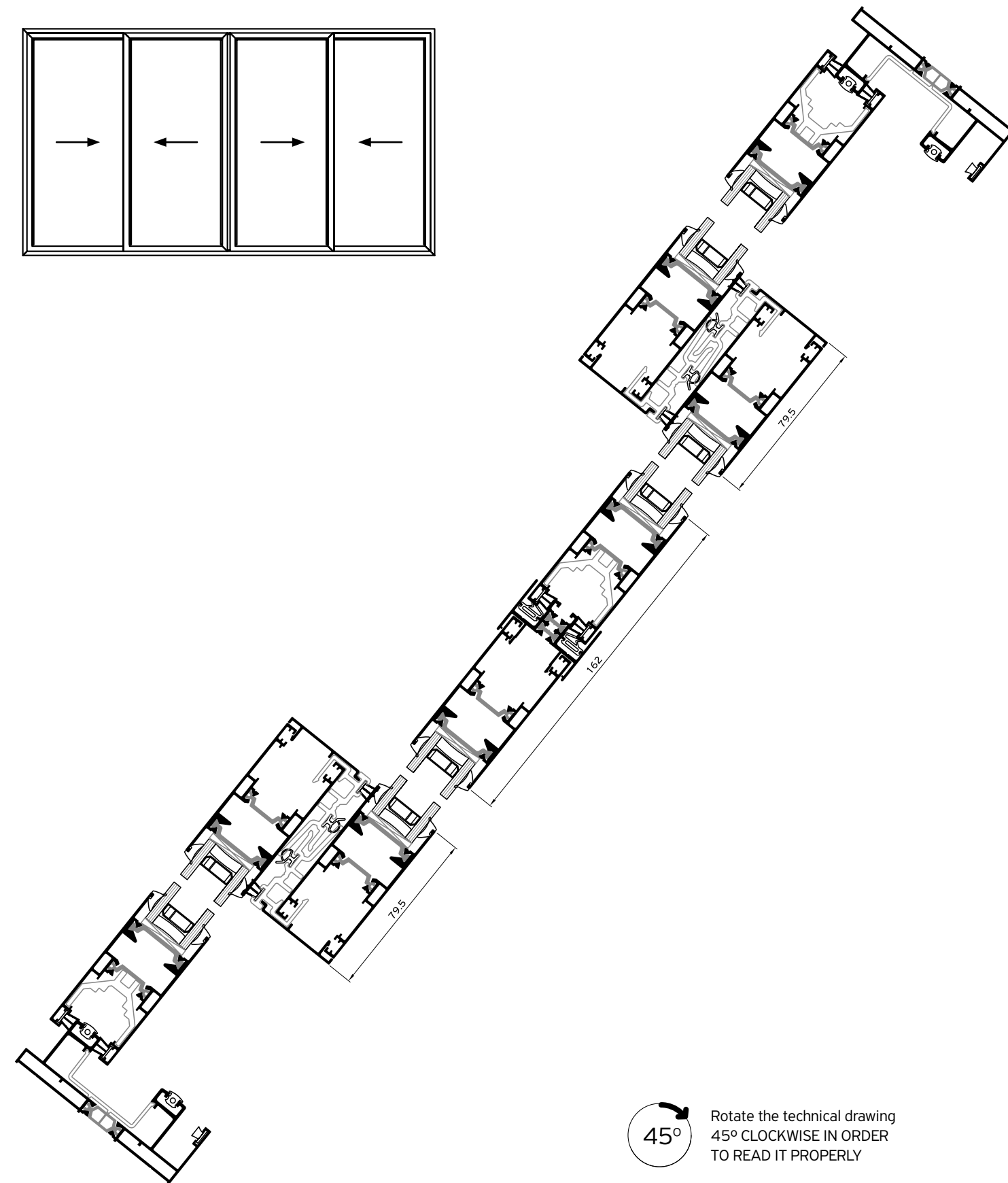
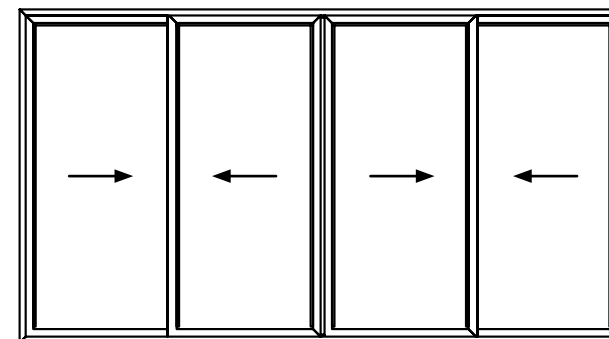

45° Rotate the technical drawing
45° CLOCKWISE IN ORDER
TO READ IT PROPERLY

Alumil SMARTIA
S350

POCKET WINDOW
2 Sashes / 1 Track
Flyscreen / Shutter

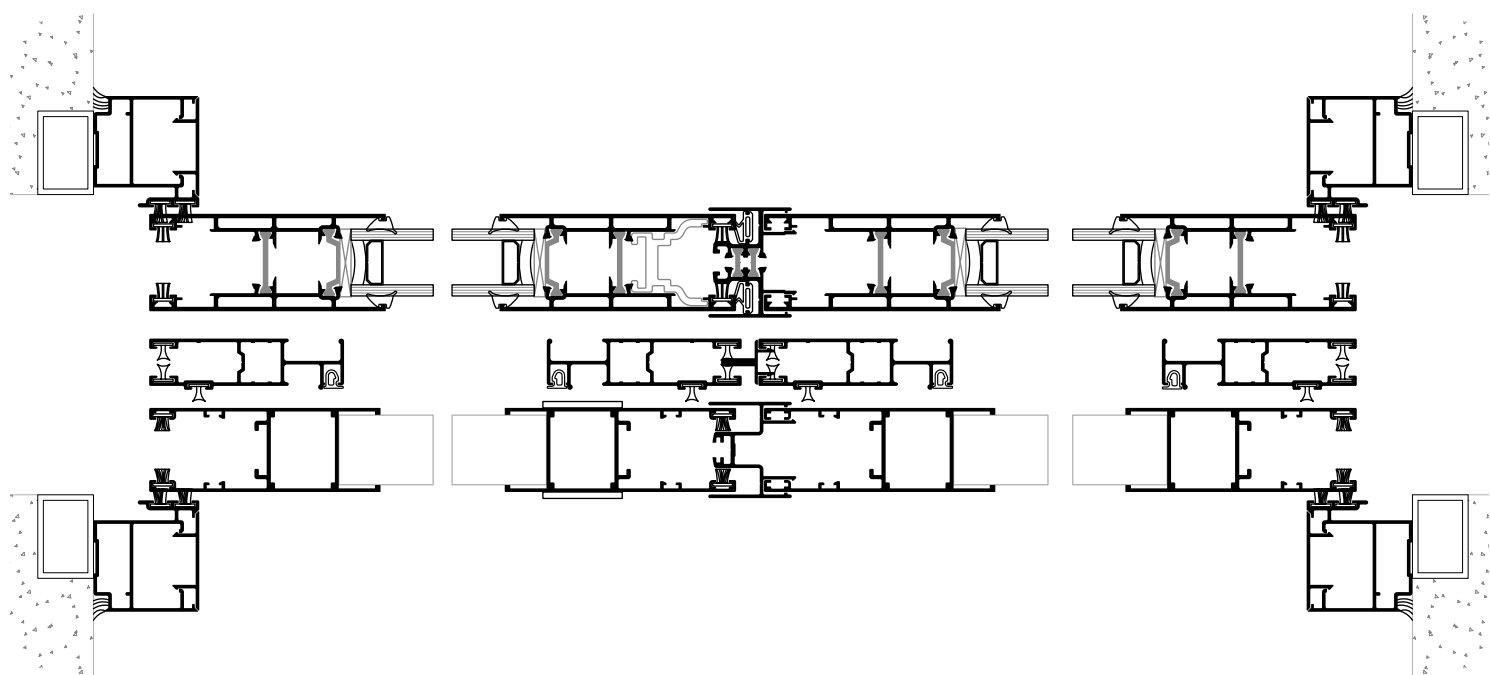
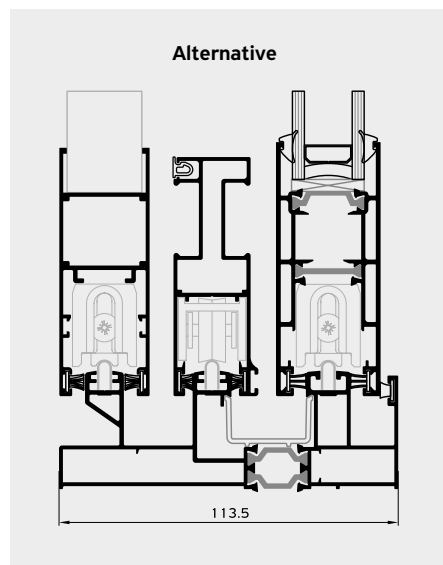
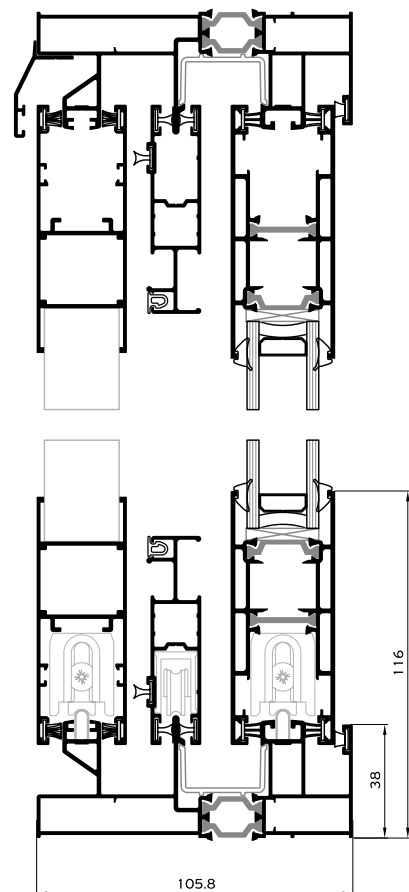
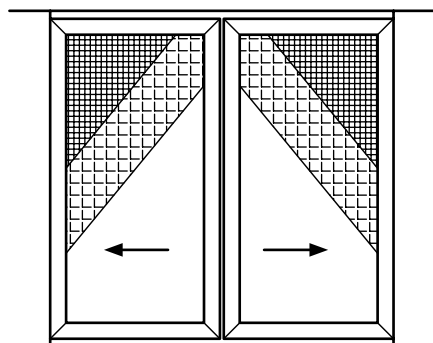

Alumil SMARTIA
S350 LT



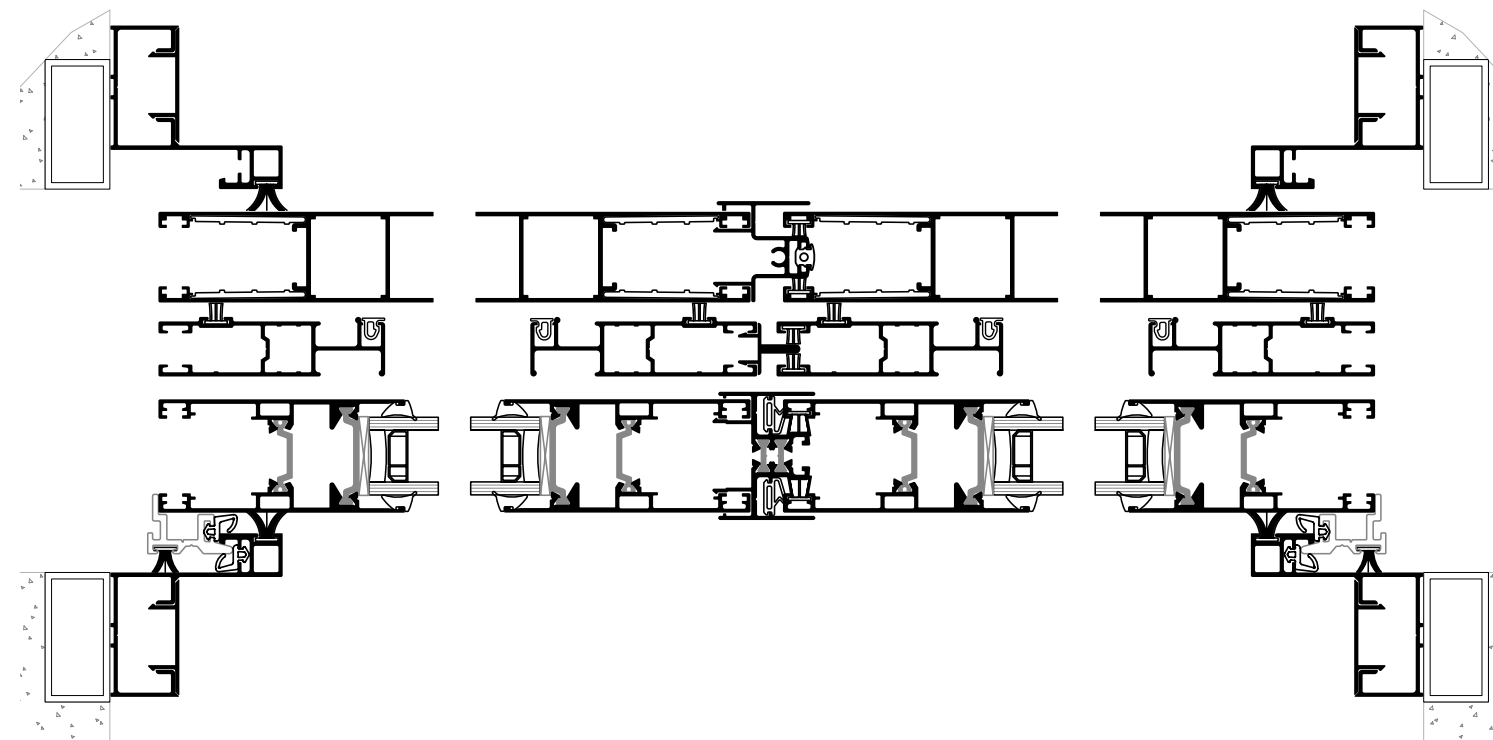
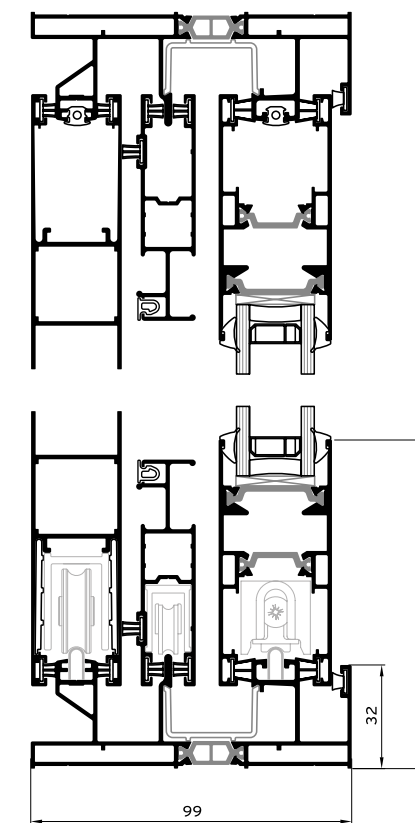
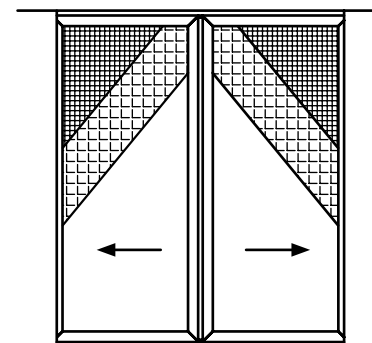



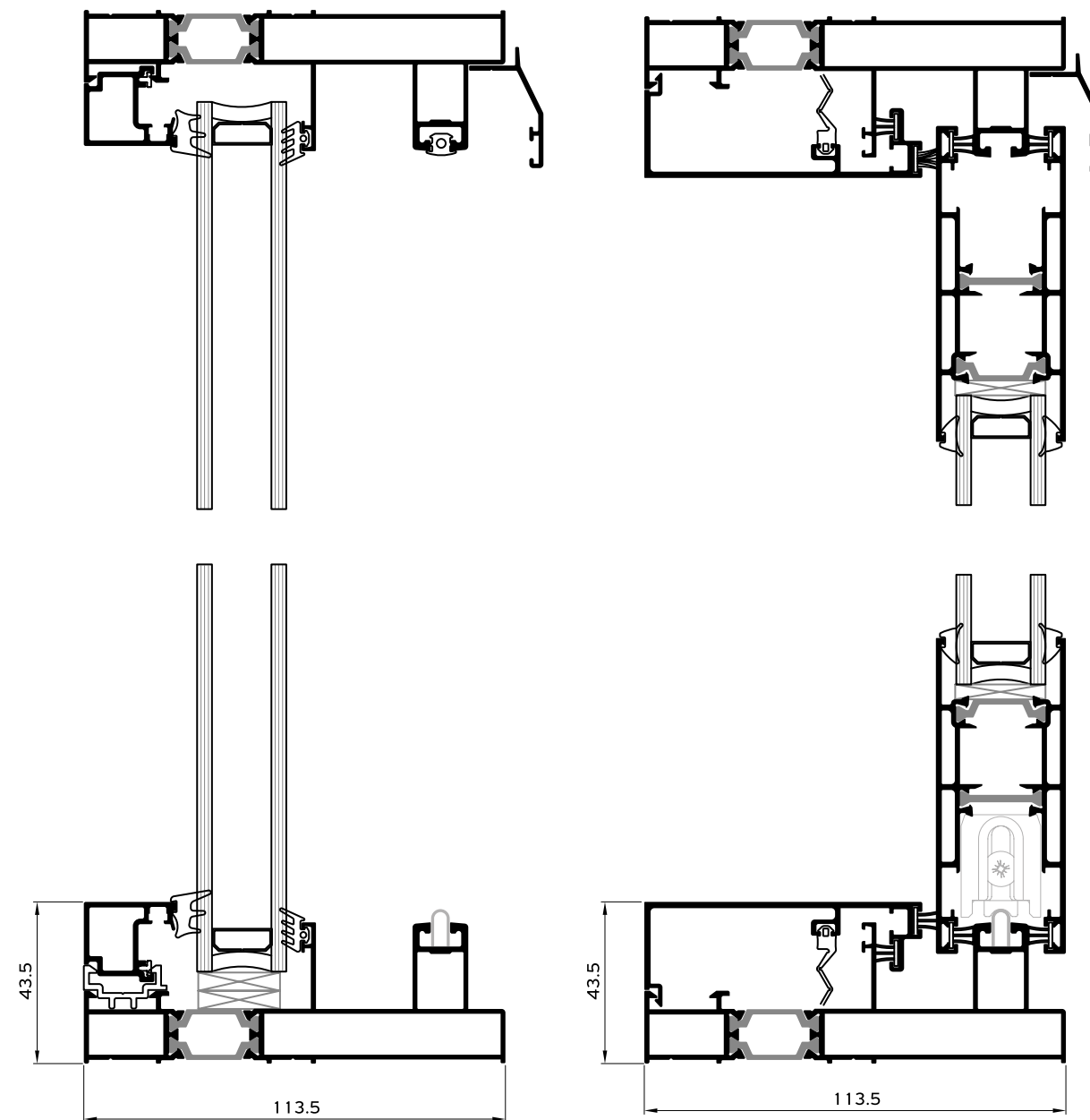
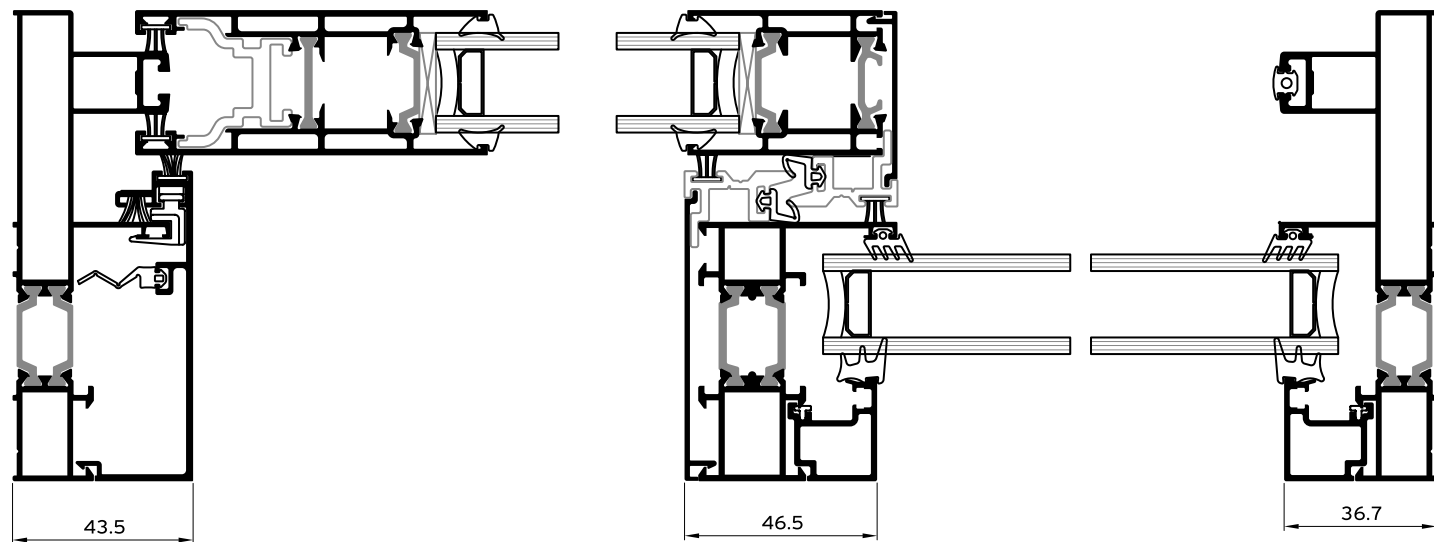
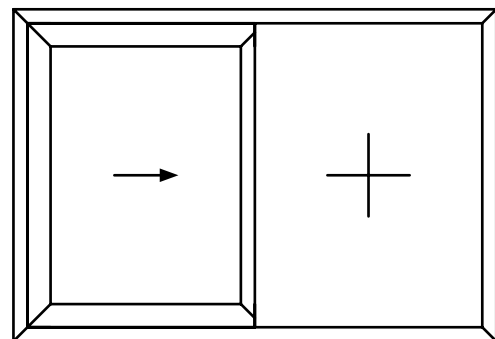



POCKET WINDOW
2 Sashes / 1 Track
Flyscreen / Shutter
Low Threshold



1 Sash / Fixed Light



Installation

-  PRECOMPRESSED MULTI-FUNCTION SEALING TAPE
-  BACKER ROD
-  HYBRID SEALANT OR NEUTRAL SILICONE
-  STYRODUR HIGH DENSITY BOARD
-  MARBLE
-  POLYURETHANE FOAM
-  POLYSTYRENE
-  WALL CONSTRUCTION
-  WALL FINISH
-  REINFORCED CONCRETE
-  AIR WATER VAPOR BARRIER TAPE

SIDE SECTION

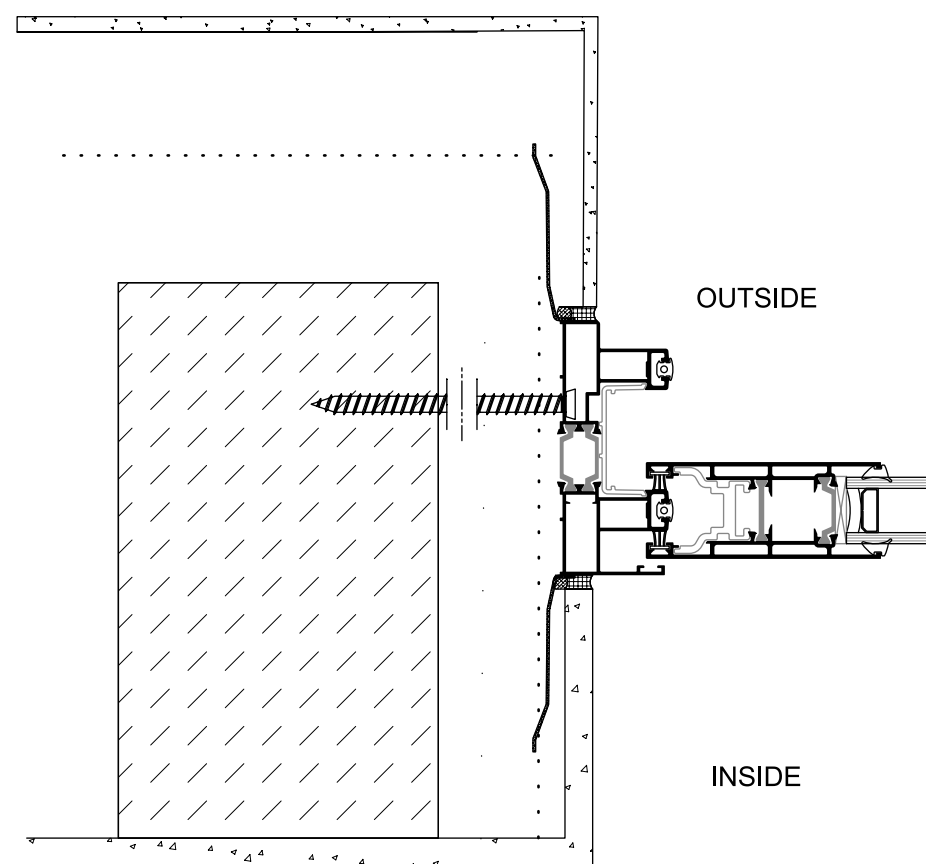



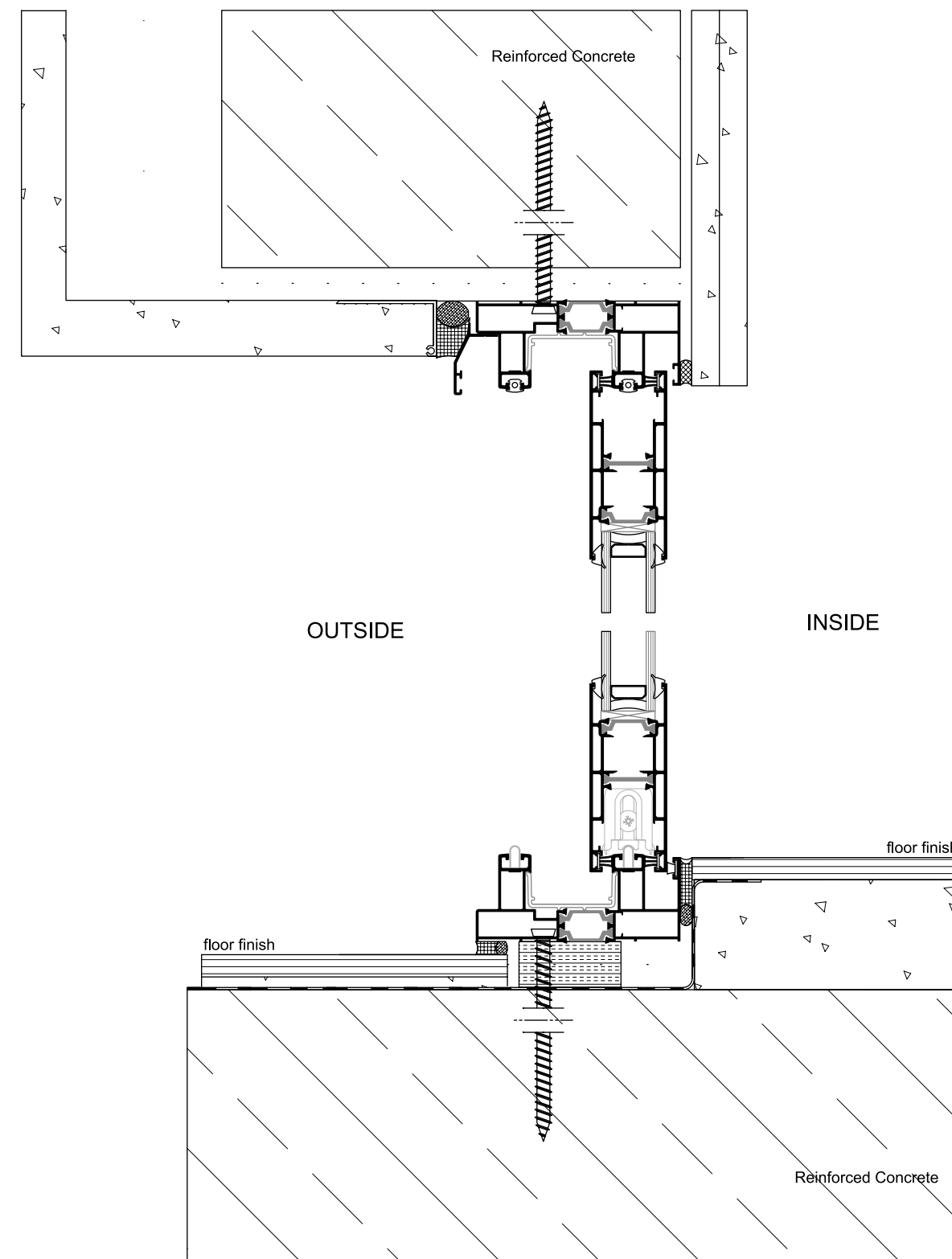







TOP SECTION



BOTTOM SECTION

Installation

-  PRECOMPRESSED MULTI-FUNCTION SEALING TAPE
-  BACKER ROD
-  HYBRID SEALANT OR NEUTRAL SILICONE
-  STYRODUR HIGH DENSITY BOARD
-  MARBLE
-  POLYURETHANE FOAM
-  POLYSTYRENE
-  WALL CONSTRUCTION
-  WALL FINISH
-  REINFORCED CONCRETE
-  AIR WATER VAPOR BARRIER TAPE

SIDE SECTION

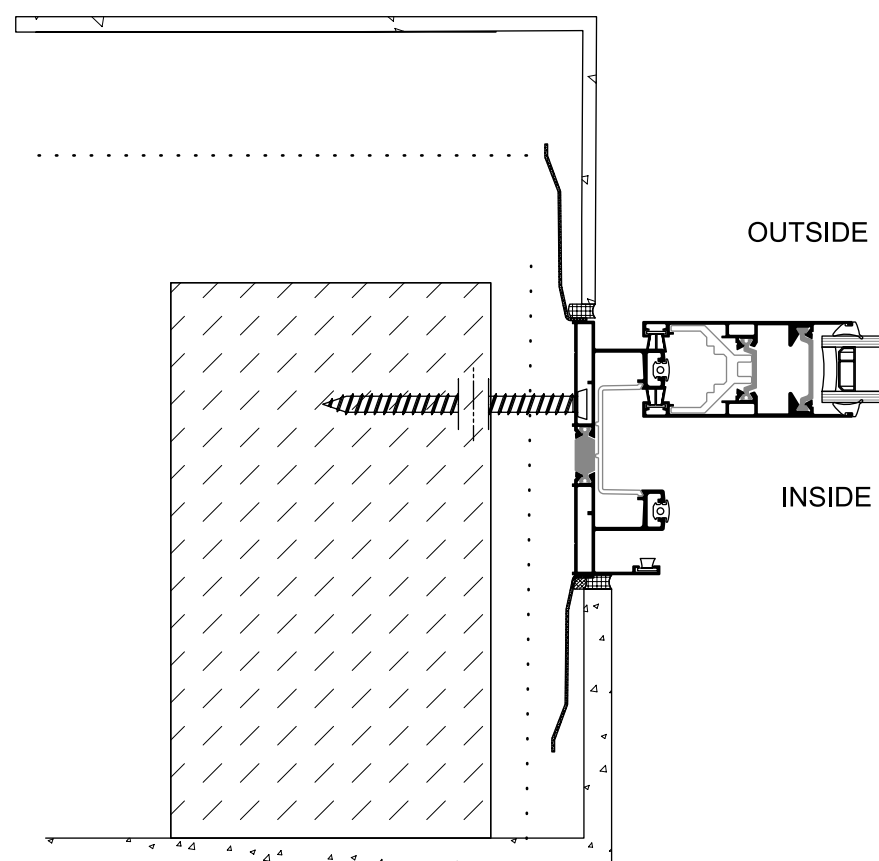

TOP SECTION

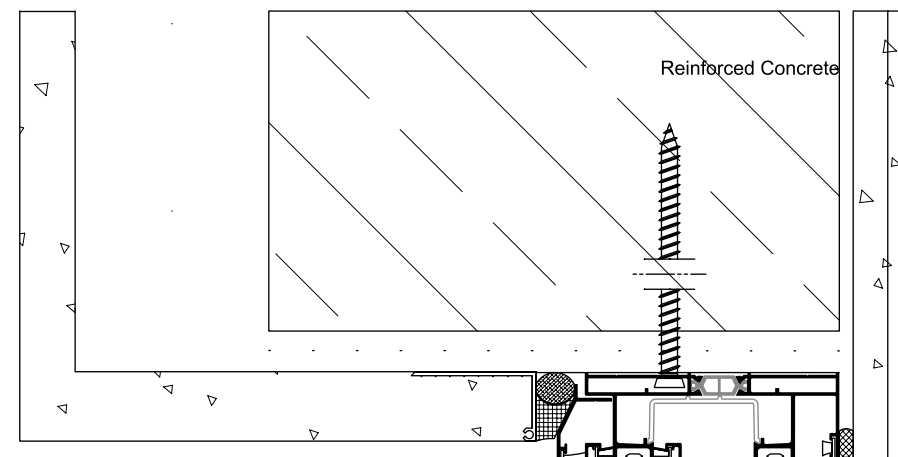

OUTSIDE

INSIDE

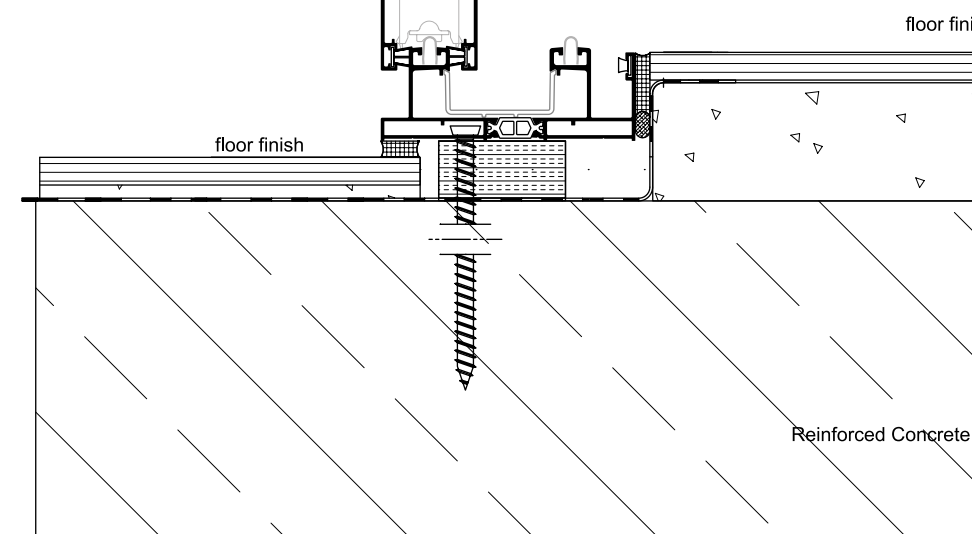

BOTTOM SECTION

Applications

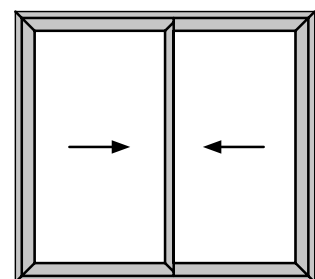

2 SASHES / 2 TRACK

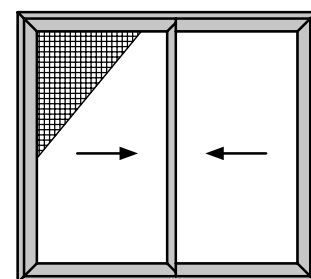

2 SASHES / 2 TRACK / FLYSCREEN

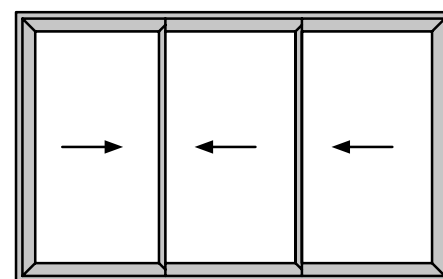

3 SASHES / 3 TRACK

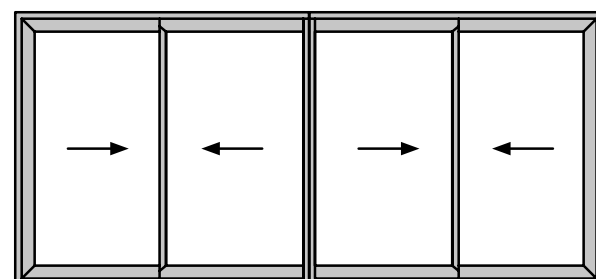

4 SASHES / 2 TRACK

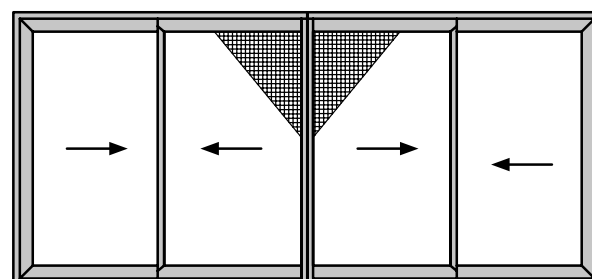

4 SASHES / 2 TRACK / FLYSCREEN

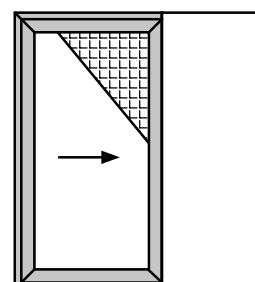

POCKET WINDOW
1 SASH / 1 TRACK / SHUTTER

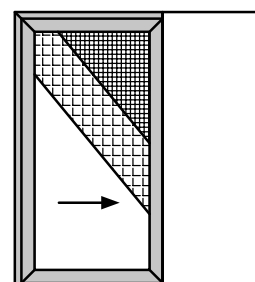

POCKET WINDOW
1 SASH / 1 TRACK / FLYSCREEN / SHUTTER

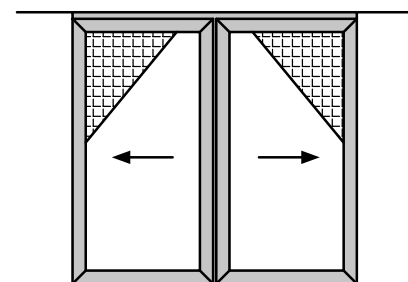

POCKET WINDOW
2 SASHES / 1 TRACK / SHUTTER

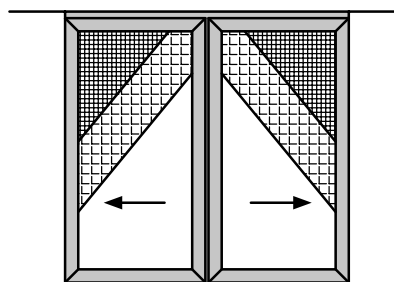

POCKET WINDOW
2 SASHES / 1 TRACK / FLYSCREEN / SHUTTER

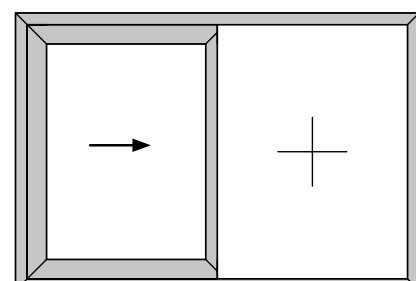

1 SASH / FIXED LIGHT

Table of performance

CERTIFICATION



WATER TIGHTNESS
EN 12208



AIR PERMEABILITY
EN 12207



WIND LOAD RESISTANCE
MAX TEST PRESSURE
EN 12210



WIND LOAD RESISTANCE
TO FRONTAL DEFLECTION
EN 12210



SOUND REDUCTION
EN 10140, EN 717

CLASSIFICATION

1A (0 Pa)	2A (50 Pa)	3A (100 Pa)	4A (150 Pa)	5A (200 Pa)	6A (250 Pa)	7A (300 Pa)	8A (450 Pa)	9A (600 Pa)
1 (150 Pa)		2 (300 Pa)		3 (600 Pa)		4 (600 Pa)		
1 (400 Pa)		2 (800 Pa)	3 (1200 Pa)		4 (1600 Pa)		5 (2000 Pa)	
A (≤ 1/150)				B (≤ 1/200)			C (≤ 1/300)	
38 dB								

ALUMIL has also certified the system SMARTIA S350 according to ASTM standards which are available upon request.

THERMAL PERFORMANCE

	DIMENSIONS IN MM (W x H)	U _w in W/m ² K (U _g = 0,8)	U _w in W/m ² K (U _g = 1,0)	U _w in W/m ² K (U _g = 1,1)
S350 2 SASHES / 2 TRACK	2300 x 2180	1,76	1,92	1,99
S350 LT 2 SASHES / 2 TRACK	2300 x 2180	1,75	1,91	1,99
S350 4 SASHES / 2 TRACK	4600 x 2180	1,71	1,87	1,95
S350 LT 4 SASHES / 2 TRACK	4600 x 2180	1,70	1,86	1,95



Cradle to Cradle Certified® is the global standard for products that are safe, circular and responsibly made

REFERENCE PROJECTS

- 1. PRIVATE RESIDENCE / LEFKADA, GREECE
- 2. TRIANGLE STUDENT HALLS / NICOSIA, CYPRUS
- 3. CRONWELL RESORT SERMILIA / CHALKIDIKI, GREECE
- 4. CARAVIA BEACH HOTEL / KOS, GREECE
- 5. DOC - TEMPORARY FLOATING HOUSE / CALARASI, ROMANIA
- 6. PRIVATE RESIDENCE / SKIATHOS, GREECE



1



2



4



3



5



6

www.alumil.com

DISCOVER MORE:



**ALUMIL
MIDDLE EAST DMCC**

MAZAYA BUSINESS AVENUE BB1
29TH FLOOR, OFFICE #2907
JUMEIRAH LAKES TOWERS, DUBAI, UAE
TEL.: +971 4 4425930
FAX: +971 4 4416528
EMAIL: marketing.uae@alumil.com
www.alumil.ae

**ALUMIL
HEADQUARTERS**

KILKIS INDUSTRIAL AREA
KILKIS - GR 61100
TEL.: +30 23410 79300
FAX.: +30 23410 71988
E-MAIL: info@alumil.com



**ALUMIL
MIDDLE EAST DMCC**

MAZAYA BUSINESS AVENUE BB1
29TH FLOOR, OFFICE #2907
JUMEIRAH LAKES TOWERS,
DUBAI, UAE
TEL.: +971 4 4425930
FAX: +971 4 4416528
EMAIL: marketing.uae@alumil.com

**ALUMIL
HEADQUARTERS**

KILKIS INDUSTRIAL AREA
KILKIS - GR 61100
TEL.: +30 23410 79300
FAX.: +30 23410 71988
E-MAIL: info@alumil.com

www.alumil.ae

alumil