



Alumil
Building excellence every day

Alumil  **IFS**
Integrated Flyscreen



CONTENTS

INTEGRATED FLYSCREEN SYSTEM

DESIGN PHILOSOPHY & CHARACTERISTICS	2
ATTENTION TO DETAIL	4
EXPLOITING EVERY CONTEMPORARY NEED	6
SECTIONS	8
INSTALLATION	12
APPLICATIONS	16

The new ALUMIL Integrated Flyscreen represents **the evolution of flyscreens ...**

for minimal sliding systems while it combines **absolute protection** from insects **with high aesthetics.**



- The new integrated flyscreen remains completely invisible, hidden into the wall providing an unobstructed view and maximizing the natural light.
- Easy and safe access thanks to flat or eclipse track, ideal for children, elders and people with special needs.
- The flyscreen can be opened to any desired position and securely be sealed with the sash.
- The operation of the flyscreen is fully controlled by spring mechanism, which efficiently prevents abrupt or rapid closure.
- During closure, the sash pushes the flyscreen, so that the interior environment is constantly protected and not exposed to insects.
- In case of maintenance, the flyscreen can be detached easily without impacting the frame or the wall finish.

DIMENSIONS

MAXIMUM WIDTH	2,0 m
MAXIMUM HEIGHT	3,2 m

ATTENTION

TO DETAIL



Specially designed Alumil branded handle
flash to the wall.

Handlebar profile designed with an
ergonomic grip, providing comfortable use,
both from the interior and exterior positions.



Uncompromising quality of mesh for
long-lasting performance, optimal
airflow and visibility.

The caterpillar at the bottom
maintains the flyscreen mesh stretched
and insures functionality over time.





The minimal design of Alumil systems **SUPREME S650 PHOS** and **SMARTIA M630 PHOS** is enhanced with the integrated flyscreen.

THE NEW SOLUTION CAN COOPERATE PERFECTLY WITH THE FOLLOWING VERSIONS:

SUPREME S650 ECLIPSE



SUPREME S650 PHOS
• LOW THRESHOLD



SMARTIA M630 PHOS
• WITHOUT SUBSILL
• WITH SUBSILL



SUPREME S650 ECLIPSE

SUPREME S650 PHOS

Low threshold

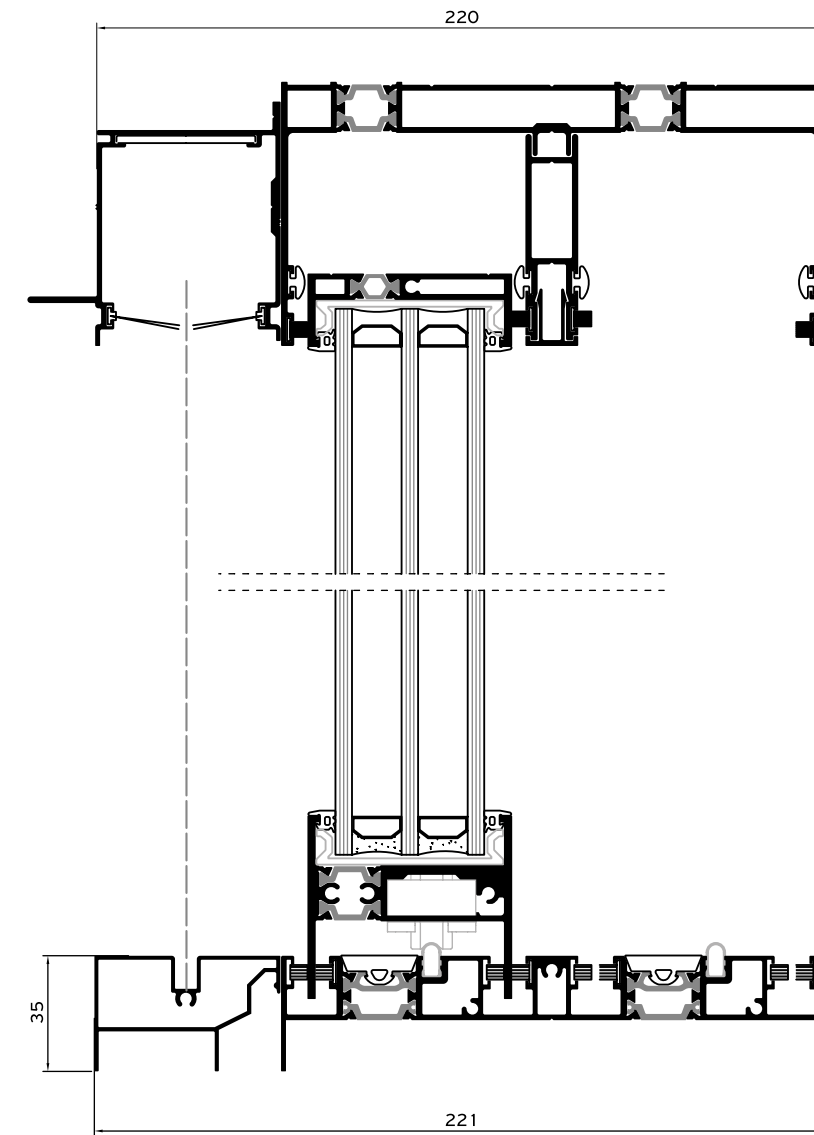
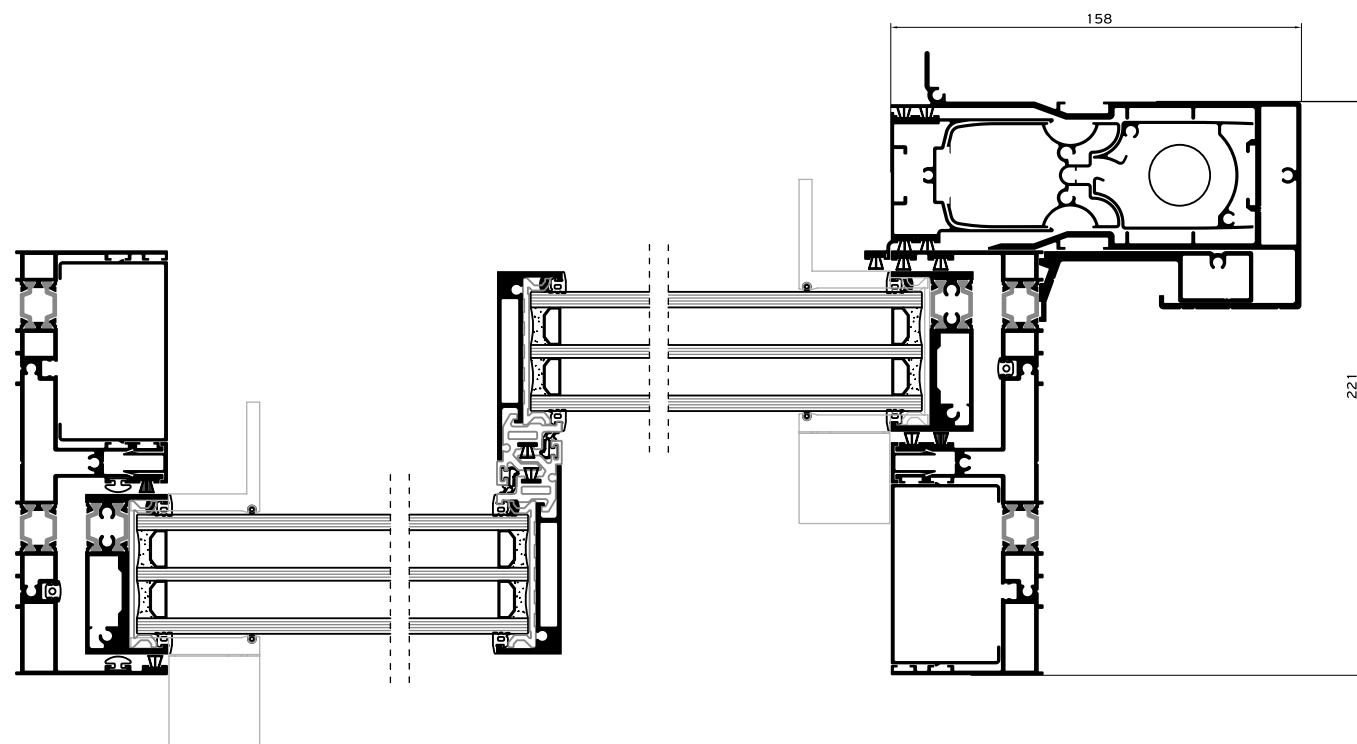
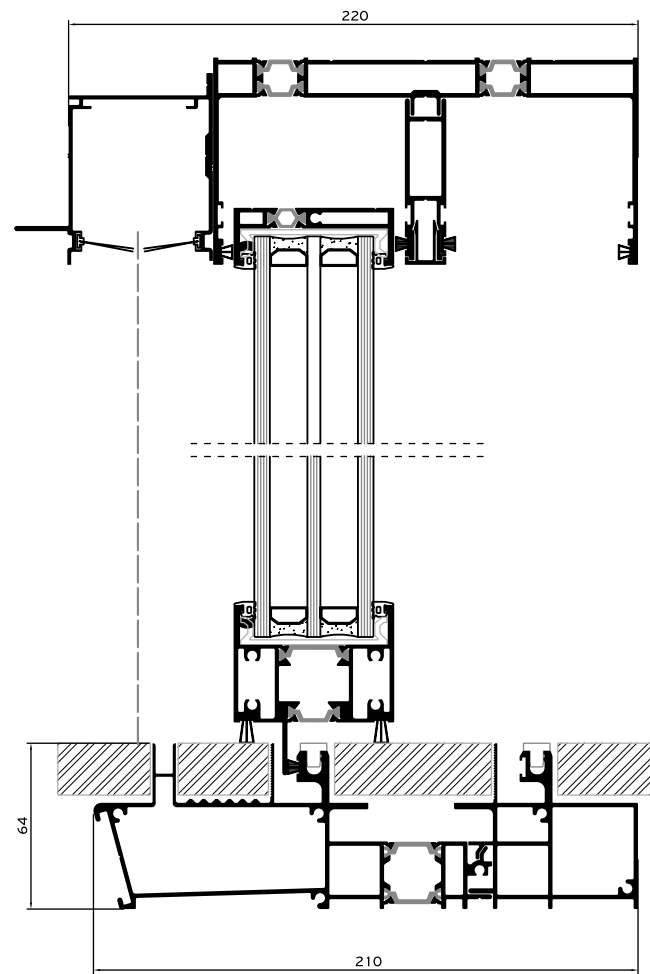

SMARTIA M630 PHOS

Without subsill

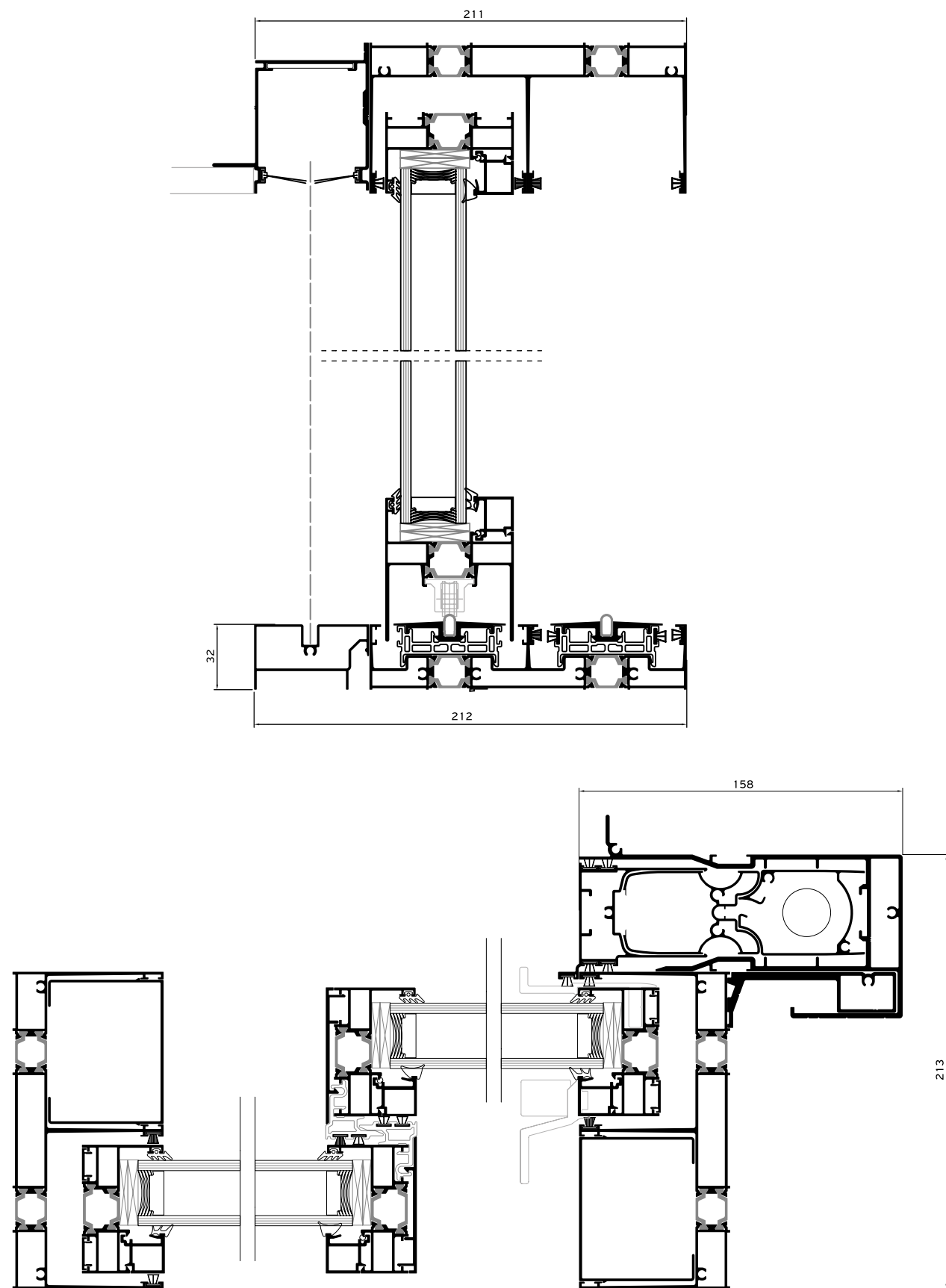





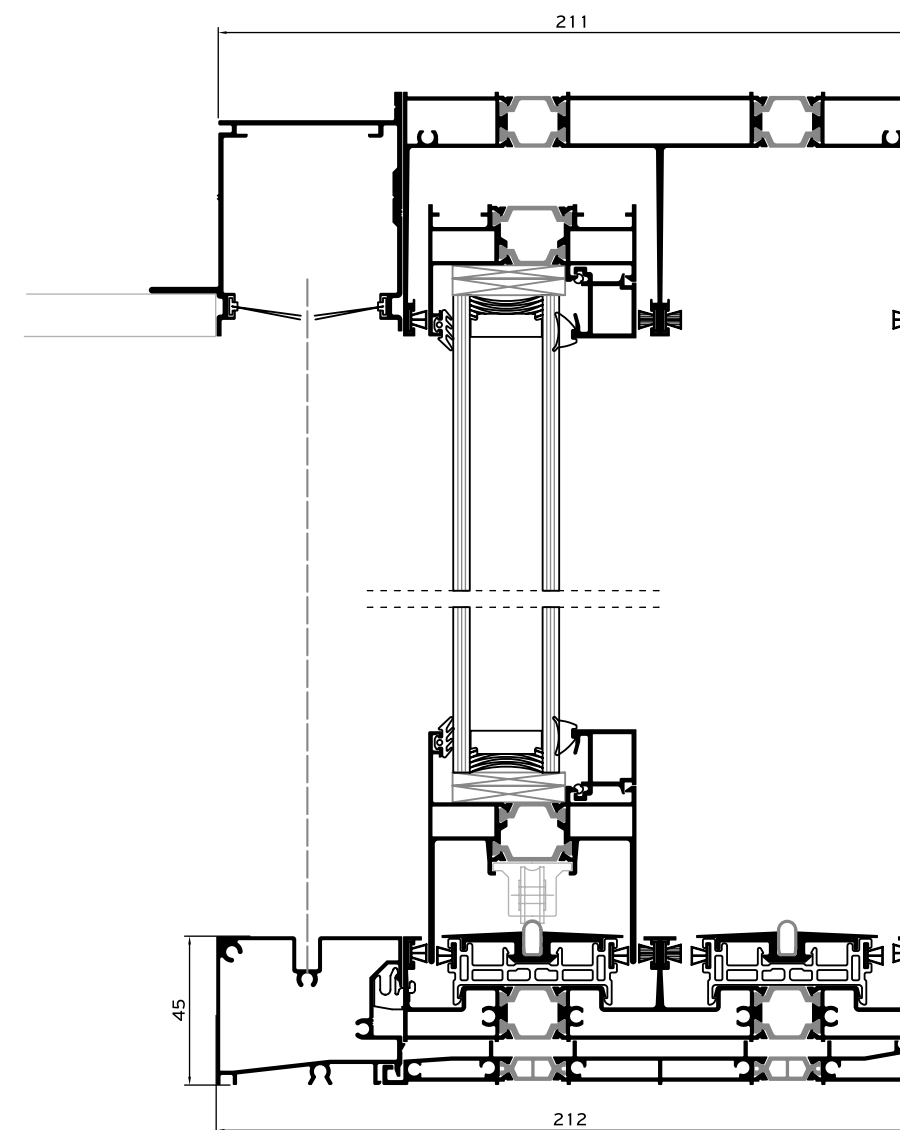





SMARTIA M630 PHOS

With subsill



Installation

-  PRECOMPRESSED MULTI-FUNCTION SEALING TAPE
-  BACKER ROD
-  HYBRID SEALANT OR NEUTRAL SILICONE
-  STYRODUR HIGH DENSITY BOARD
-  MARBLE
-  POLYURETHANE FOAM
-  POLYSTYRENE
-  WALL CONSTRUCTION
-  WALL FINISH
-  REINFORCED CONCRETE
-  AIR WATER VAPOR BARRIER TAPE

TOP SECTION

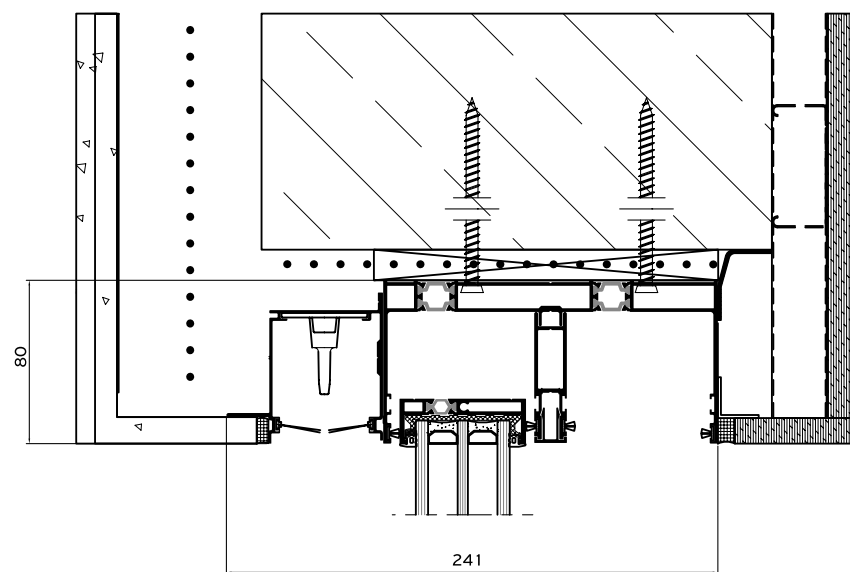

SIDE SECTION A FOR NEW BUILDINGS

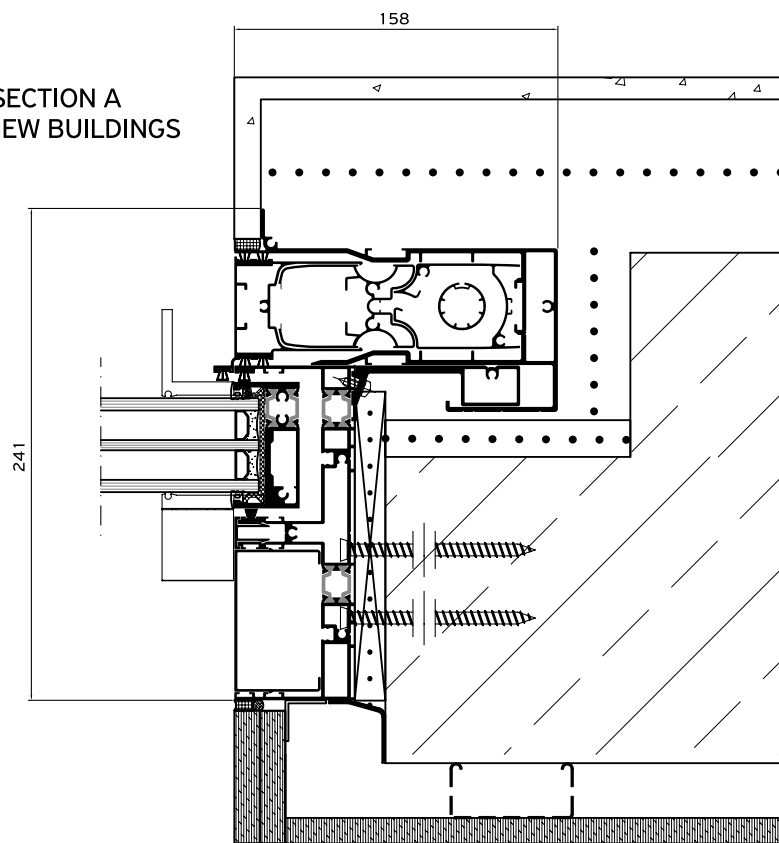

SIDE SECTION B FOR NEW BUILDINGS

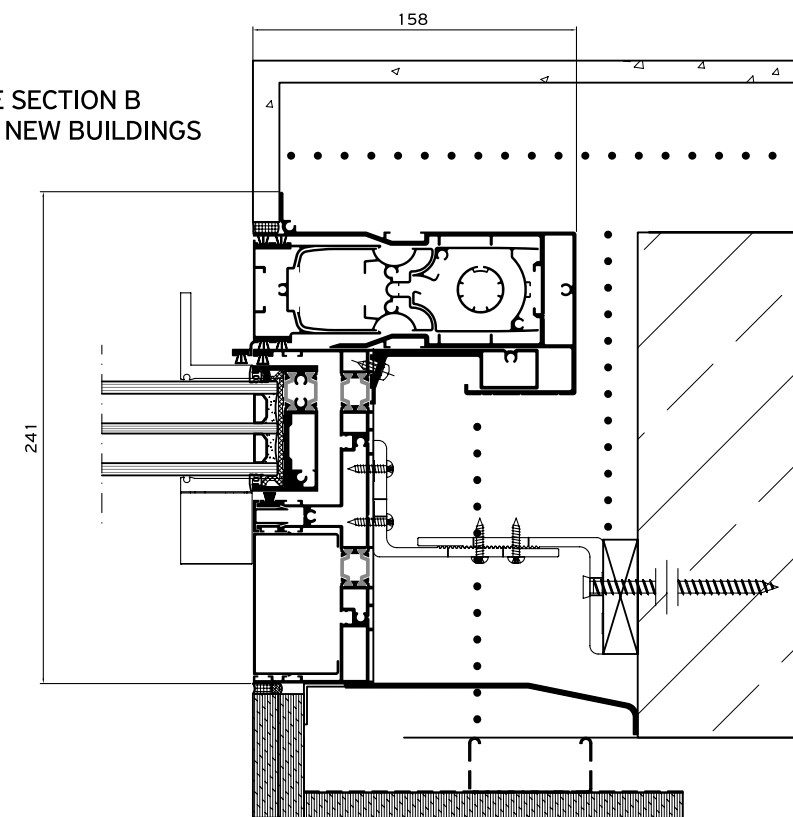

SIDE SECTION C FOR RENOVATIONS

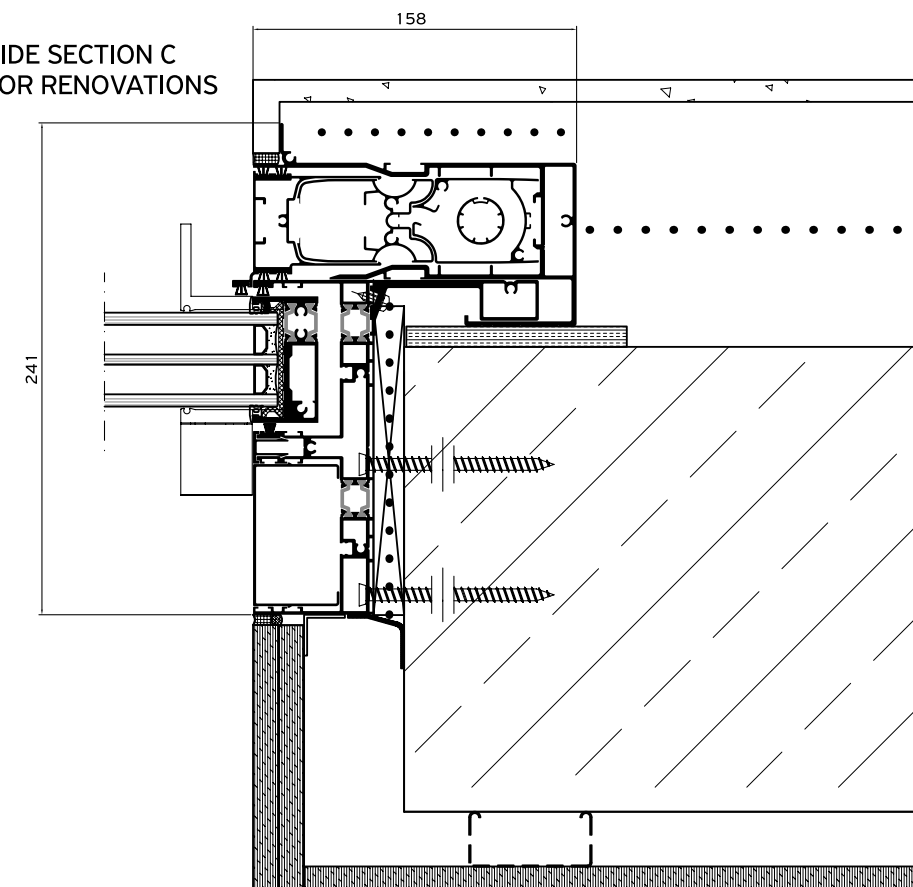

Installation

SUPREME S650 ECLIPSE

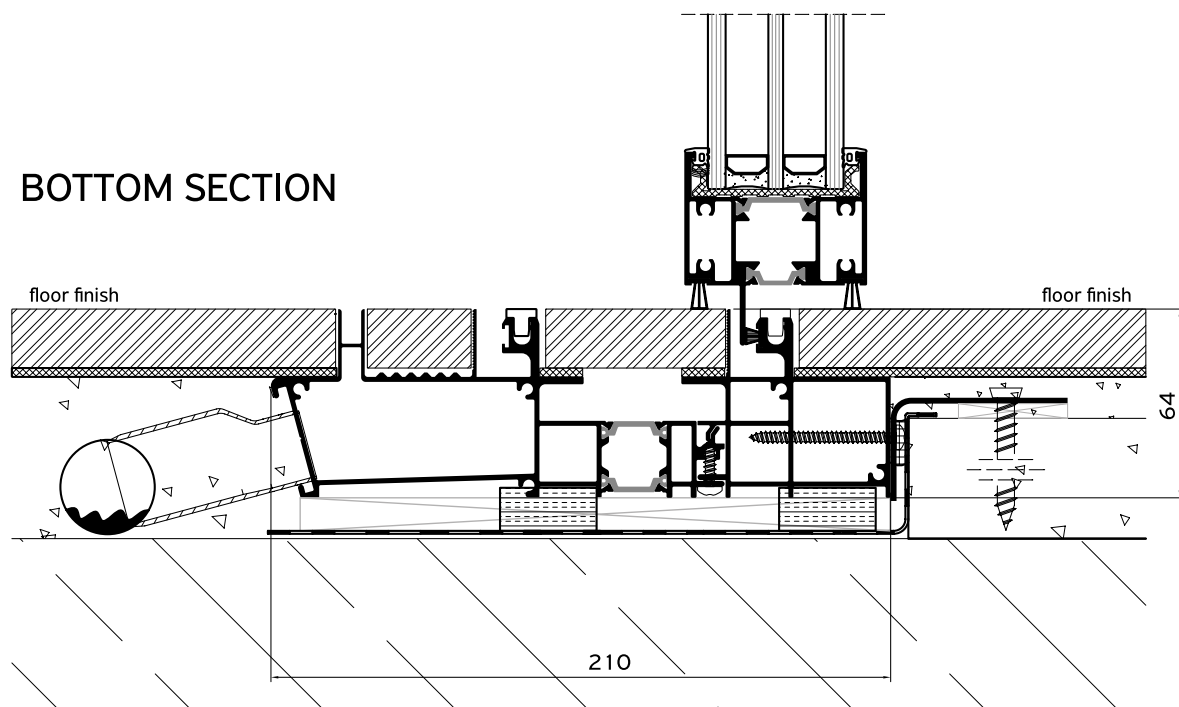

SMARTIA M630 PHOS

Without subsill

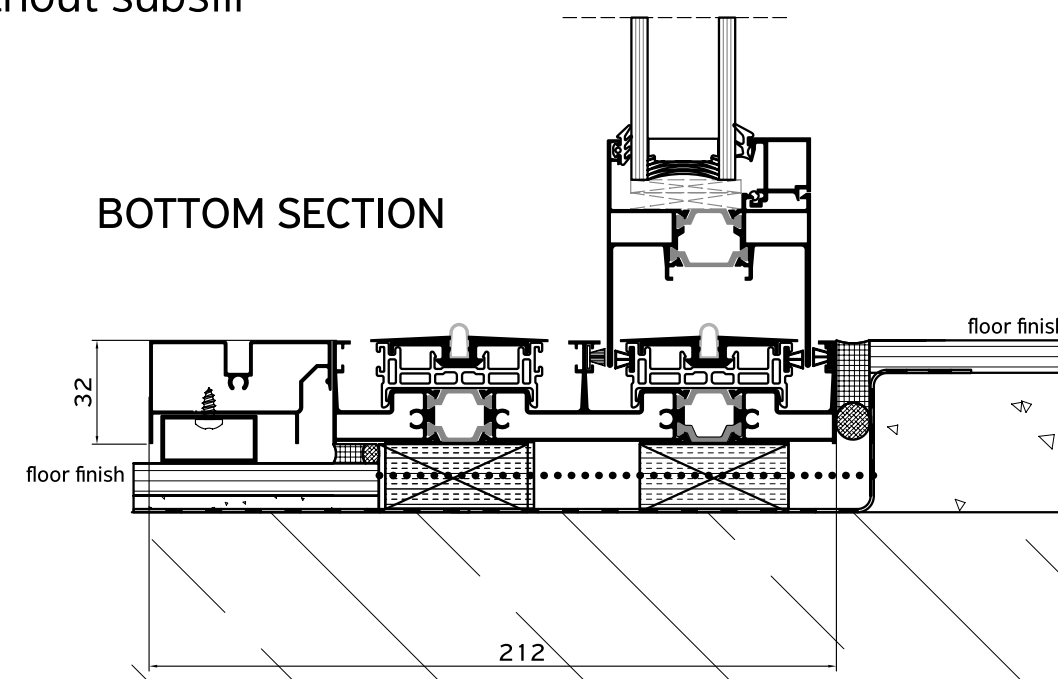

SUPREME S650 PHOS

Low threshold

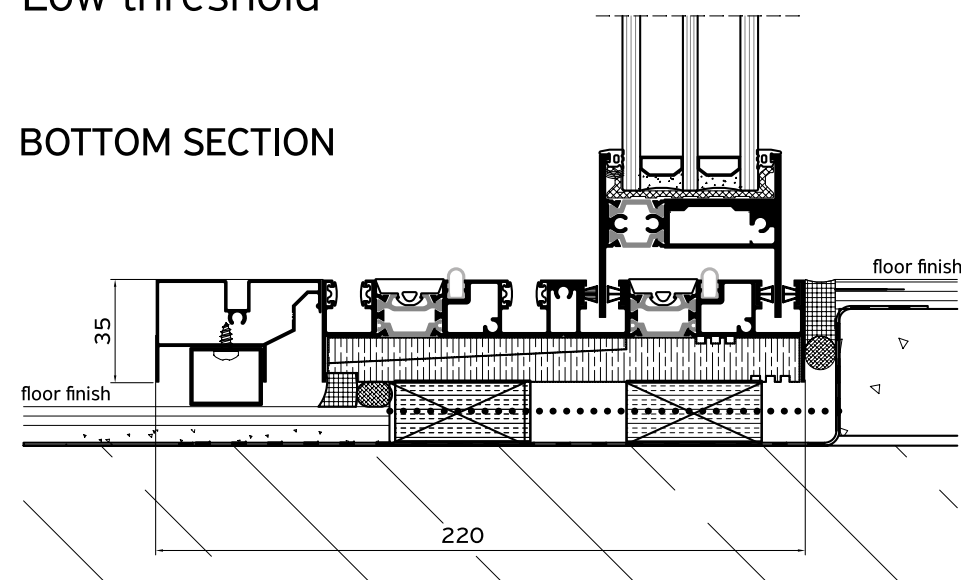

SMARTIA M630 PHOS

With subsill

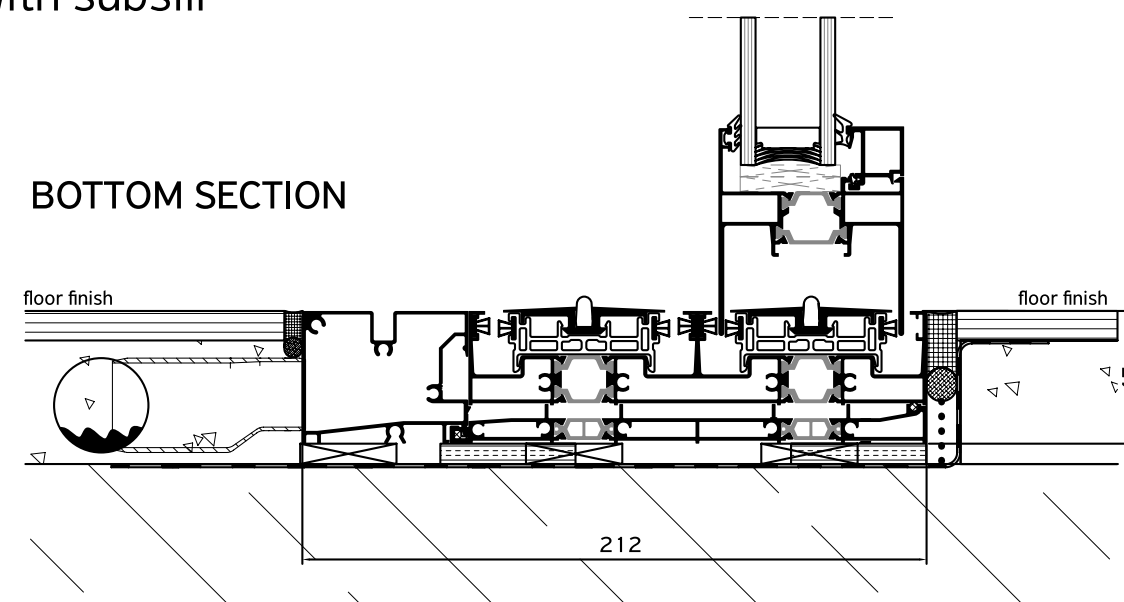

Applications

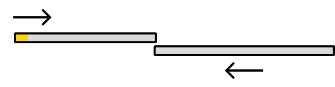
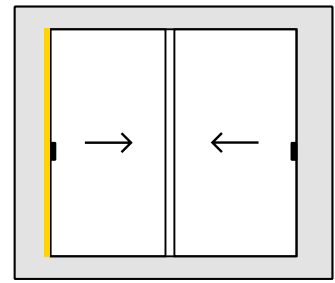

2 SASHES / 2 TRACK

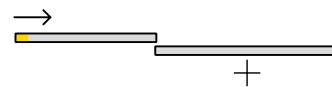
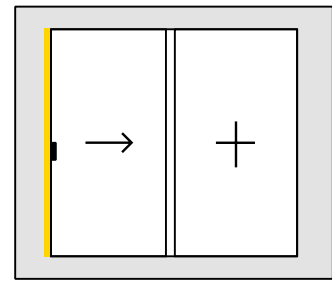

1 SASH / FIXED LIGHT

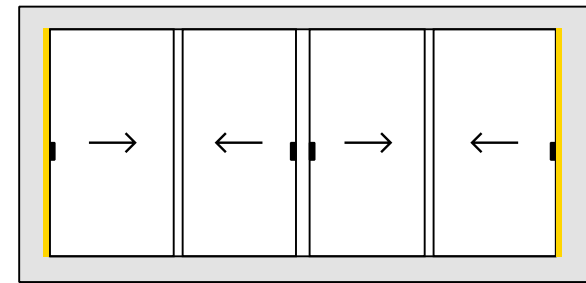

4 SASHES / 2 TRACK

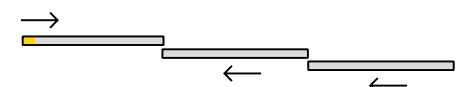
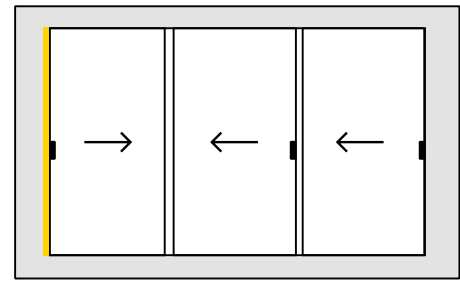

3 SASHES / 3 TRACK

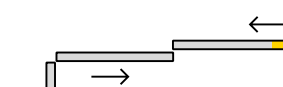
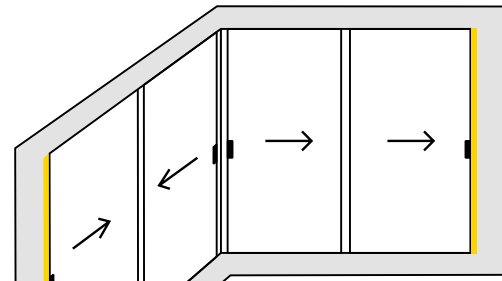

INTERNAL / EXTERNAL CORNER
4 SASHES / 2 TRACK

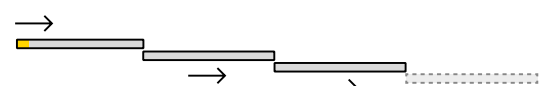
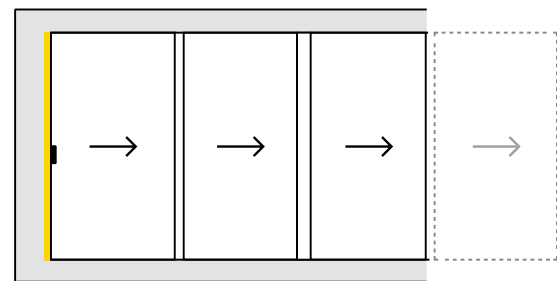

MULTITRACK

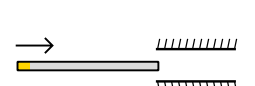
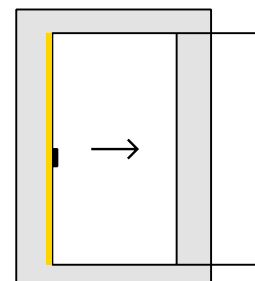

1 SASH / 1 TRACK

**ALUMIL
HEAD OFFICES
& SHOWROOM - THESSALONIKI**

GOGOUSI 8, EFKARPIA
THESSALONIKI - GR 56429

TEL.: +30 2313 011000
FAX.: +30 2310 692473
EMAIL.: info@alumil.com

**ALUMIL
HEADQUARTERS**

KILKIS INDUSTRIAL AREA
KILKIS - GR 61100

TEL.: +30 23410 79300
FAX.: +30 23410 71988
EMAIL.: info@alumil.com

www.alumil.com

EN JUNE 2023

alumil